

Flat Roller

THK General Catalog

A Product Descriptions

Features and Types	A11-2
Features of the Flat Roller	A11-2
• Structure and Features	A11-2
Types of the Flat Roller	A11-3
• Types and Features	A11-3
Point of Selection	A11-4
Rated Load and Nominal Life	A11-4
Accuracy Standards	A11-7
Dimensional Drawing, Dimensional Table	
Model FT	A11-8
Model FTW	A11-9
Point of Design	A11-10
Raceway	A11-10
Installing the Flat Roller	A11-11
Model No.	A11-13
• Model Number Coding	A11-13
Precautions on Use	A11-14

B Support Book (Separate)

Features and Types	B11-2
Features of the Flat Roller	B11-2
• Structure and Features	B11-2
Types of the Flat Roller	B11-3
• Types and Features	B11-3
Point of Selection	B11-4
Rated Load and Nominal Life	B11-4
Mounting Procedure	B11-7
Model No.	B11-9
• Model Number Coding	B11-9
Precautions on Use	B11-10

Features of the Flat Roller

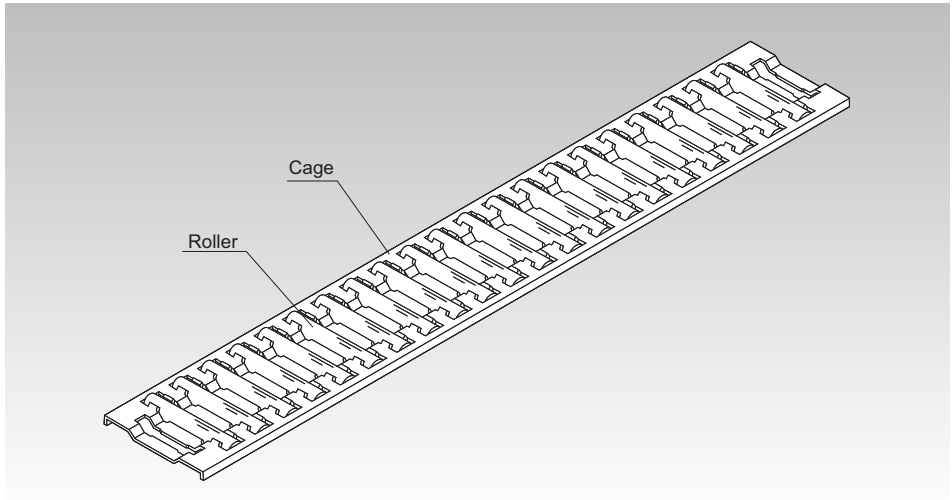

Fig.1 Structure of LM Flat Roller Model FT

Structure and Features

For the Flat Roller, precision rollers compliant with JIS B1506 are installed in a thin, steel plate cage, which is formed into an "M" shape for improved rigidity and light weight. The pockets of the cage are designed to prevent the rollers from falling out. The Flat Roller is sandwiched between two raceways, so it moves half the distance traveled by the table. For example, if the table moves 500 mm, the Flat Roller moves 250 mm in the same direction.

The Flat Roller is optimal for large machine tools such as planer, horizontal milling machines and cylindrical grinding machines, and for locations requiring high accuracy such as surface grinding machines, cylindrical grinder and optic measuring machines.

[Large Load Capacity]

Since rollers are installed in short pitches, the Flat Roller has a large load capacity, and depending on the conditions, it can be used on the raceway of a mold that is little hardened. In addition, the deflection rigidity of the table is almost the same as that of a sliding surface.

Features and Types

Types of the Flat Roller

[Combined Accuracy of 90° V Surface and Flat Surface Supported as Standard]

The Flat Roller is designed so that it can be mounted on the 90° V-flat sliding surface, which is the most common configuration among narrow guide types of tables and saddles of machinery. It allows the product to be used without major design change.

[Lowest Friction among Roller Type LM Systems]

Since the rollers are evenly held in a light, rigid cage, friction between rollers is eliminated and skewing of the rollers is minimized. As a result, a small friction coefficient ($\mu = 0.001$ to 0.0025) is achieved, and stick-slip, which is problematic with sliding surfaces, does not occur.

[Instant Connection of the Cage]

When installing the Flat Roller in a large machine, it can easily be connected on the bed. This allows the Flat Roller to be installed even with the longest type.

Types of the Flat Roller

Types and Features

Model FT/FT-V

These models have a single row of rollers and are mainly used on the flat surface.

Specification Table⇒ [A 11-8](#)

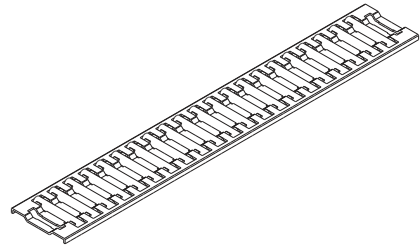

Models FT/FT-V

Model FTW/FTW-V

These models have two or more rows of rollers, and their cages are shaped to bend at 90°. Each model uses rollers with a diameter 0.7071 times greater than that of the rollers on the flat surface so that model FT or FT-V can be mounted on the 90° V surface at the same height if model FT or FT-V is used on the flat surface.

Specification Table⇒ [A 11-9](#)

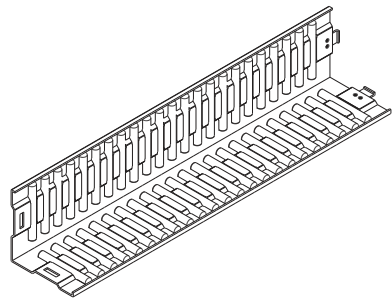

Models FTW/FTW-V

Rated Load and Nominal Life

[Static Safety Factor f_s]

The Flat Roller may receive an unexpected external force while it is stationary or operative due to the generation of an inertia caused by vibrations and impact or start and stop. It is necessary to consider a static safety factor against such a working load.

$$f_s = \frac{f_H \cdot f_T \cdot f_C \cdot C_o}{P_c}$$

f_s : Static safety factor

f_H : Hardness factor (see Fig.1 on **A11-6**)

f_T : Temperature factor (see Fig.2 on **A11-6**)

f_C : Contact factor

(see [Load Rating] and [Nominal Life] on **A11-5**)

C_o : Basic static load rating (kN)

P_c : Calculated radial load (kN)

● Reference Value of Static Safety Factor

The static safety factors indicated in Table1 are the lower limits of reference values in the respective conditions.

Table1 Reference Value of Static Safety Factors (f_s)

Machine using the LM system	Load conditions	Lower limit of f_s
General industrial machinery	Without vibration or impact	1 to 1.3
	With vibration or impact	2 to 3
Machine tool	Without vibration or impact	1 to 1.5
	With vibration or impact	2.5 to 7

Point of Selection

Rated Load and Nominal Life

[Load Rating]

The rated loads shown in the specification tables represent the rated loads with a unit length (ℓ) in the directions indicated in the figure below.

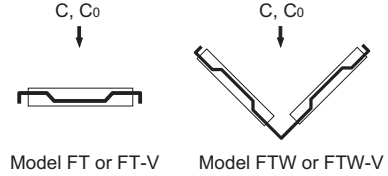

If the length of the Flat Roller in the effective load range differs from the unit length (ℓ), approximate rated loads (C_{ℓ} and $C_{0\ell}$) can be obtained using the following equation.

$$C_{\ell} = \left(\frac{\ell_0}{\ell} \right)^{\frac{3}{4}} \times C$$

$$C_{0\ell} = \frac{\ell_0}{\ell} \cdot C_0$$

- C_{ℓ} : Basic dynamic load rating
in the effective load range (kN)
- ℓ_0 : Length in effective load range (mm)
- ℓ : Unit length
(see the specification table) (mm)
- $C_{0\ell}$: Basic static load rating
in the effective load range (kN)
- C : Basic dynamic load rating (kN)
- C_0 : Basic static load rating (kN)

Note) Note that if the hardness of the raceway is lower than 58 HRC, the rated loads will be decreased. (See Fig.1 on **A11-6**.)

[Nominal Life]

When the basic dynamic load rating (C_{ℓ}) of the Flat Roller in the effective load range has been obtained from the equation above, the nominal life is obtained using the following equation.

$$L = \left(\frac{f_H \cdot f_c \cdot f_T}{f_W} \cdot \frac{C_{\ell}}{P_C} \right)^{\frac{10}{3}} \times 100$$

- L : Nominal life (km)
(The total number of revolutions that 90% of a group of identical Flat Roller units independently operating under the same conditions can achieve without showing flaking)
- C_{ℓ} : Basic dynamic load rating (kN)
- P_C : Calculated radial load (kN)
- f_H : Hardness factor (see Fig.1 **A11-6**)
- f_T : Temperature factor (see Fig.2 **A11-6**)
- f_W : Load factor (see Table2 **A11-6**)
- f_c : Contact factor^{Note)}

Note) Contact factor is determined according to the contact state of the two planes between which the rollers travel. If the contact ratio between the two planes is 50%, set the contact factor as $f_c = 0.5$ for safety's sake.

[Calculating the Service Life Time]

When the nominal life (L) has been obtained, if the stroke length and the number of reciprocations per minute are constant, the service life time is obtained using the following equation.

$$L_h = \frac{L \times 10^6}{2 \times \ell_s \times n_1 \times 60}$$

L_h : Service life time (h)
 ℓ_s : Stroke length (mm)
 n_1 : Number of reciprocations per minute (min^{-1})

● f_H : Hardness Factor

To maximize the load capacity of the LM system, the hardness of the raceways needs to be between 58 to 64 HRC. If the hardness is lower than this range, the basic dynamic load rating and the basic static load rating decrease. Therefore, it is necessary to multiply each rating by the respective hardness factor (f_H).

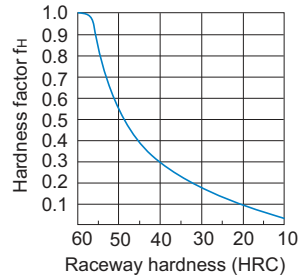

Fig. 1 Hardness Factor (f_H)

● f_T : Temperature Factor

If the temperature of the environment surrounding the operating Flat Roller exceeds 100°C , take into account the adverse effect of the high temperature and multiply the basic load ratings by the temperature factor indicated in Fig. 2.

Note) If the environment temperature exceeds 100°C , contact THK.

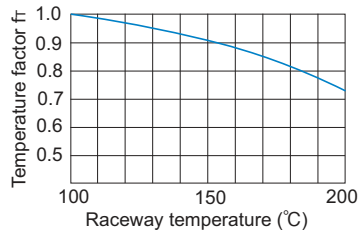

Fig. 2 Temperature Factor (f_T)

● f_w : Load Factor

In general, reciprocating machines tend to involve vibrations or impact during operation. It is extremely difficult to accurately determine vibrations generated during high-speed operation and impact during frequent start and stop. Therefore, when the actual load applied cannot be obtained, or when speed and impact have a significant influence, divide the basic load rating (C or C_0), by the corresponding load factor in Table 2 of empirically obtained data.

Table 2 Load Factor (f_w)

Vibrations/impact	Speed(V)	f_w
Faint	Very low $V \leq 0.25\text{m/s}$	1 to 1.2
Weak	Slow $0.25 < V \leq 1\text{m/s}$	1.2 to 1.5
Medium	Medium $1 < V \leq 2\text{m/s}$	1.5 to 2
Strong	High $V > 2\text{m/s}$	2 to 3.5

Accuracy Standards

The accuracy of the Flat Roller is classified into normal grade, high accuracy grade and precision grade according to the difference in diameter between the rollers incorporated in a single cage. When it is necessary to specify the dimensional tolerance in the roller diameter for reasons related to the required accuracy or combination, select the desired accuracy from Table3 and specify the corresponding accuracy symbol.

Table3 Classification of Roller Diameters for Selection

Unit: μm

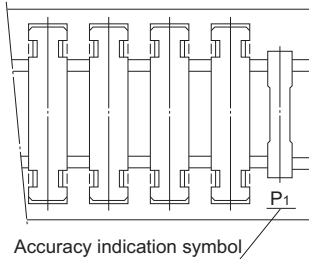
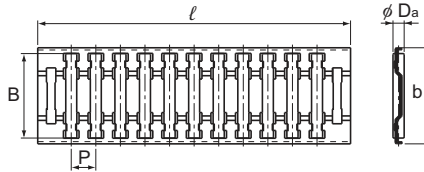

Fig.3

Accuracy grades	Diameter difference	Dimensional tolerance in diameter	Accuracy indication symbol
Normal grade	3	0 to -3	No Symbol
High grade	2	0 to -2	H2
		-2 to -4	H4
		-4 to -6	H6
Precision grade	1	0 to -1	P1

Note) The accuracy indication symbol is marked on the end of the cage as shown in Fig.3.

Model FT



FT2010-32 to FT5030V-250
FT10060V-500

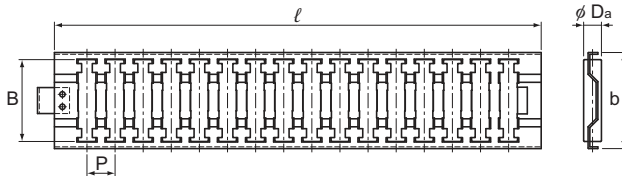

FT10054-400
FT10080-500

Unit: mm

Model No.	Main dimensions		Roller dimensions				Basic dynamic load rating	Basic static load rating	Mass g
	Width	Length	Diameter	Length	No. of rollers	Pitch	C		
	b	ℓ	D _a	B	Z	P	kN		
FT 2010-32	10	32	2	7.8	7	4	5.2	10.4	1.9
FT 2515-45	15	45	2.5	11.8	7	4.75	10.9	25.2	5.6
FT 3020-60	20	60	3	15.8	8	5.51	17.4	42.8	12.5
FT 3525-75	25	75	3.5	19.8	8	7	27.4	72.7	23
FT 4030-150	30	150	4	25.8	18	7.3	55.7	176	73
FT 4035-150	35	150	4	30.8	18	7.3	64.2	212	86
FT 4026V-150	26	150	2.828	22.8	22	6	45.1	155	45
FT 5038-250	38	250	5	32.8	21	11	109	387	195
FT 5043-250	43	250	5	37.8	21	11	122	449	200
FT 5030V-250	30	250	3.535	21.8	33	7	78	290	103
FT 10054-400	54	400	10	46	24	15.8	279	1000	870
FT 10080-500	80	500	10	71.8	29	16	459	1900	1610
FT 10060V-500	60	500	7.071	52.8	35	13.5	301	1270	870

Model number coding

FT5038 P1 -750L

Model number Accuracy indication symbol ^(*) Overall cage length (in mm)

(*) See **A11-7**.

Model FTW

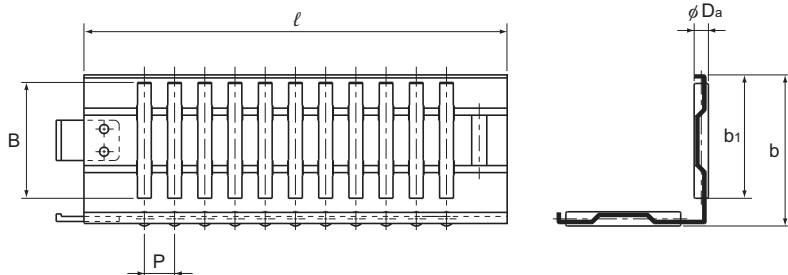

Unit: mm

Model No.	Main dimensions			Roller dimensions				Basic dynamic load rating	Basic static load rating	Mass
	Width		Length	Diameter	Length	No. of rollers	Pitch	C	C ₀	
	b	b ₁	ℓ	D _s	B	Z	P	kN	kN	g
FTW 4030V-150	30	24.5	150	2.828	22.8	22×2	6	59	220	94
FTW 5045-250	45	35.5	250	5	32.8	21×2	11.1	142	548	410
FTW 5050-250	50	40.5	250	5	37.8	23×2	10	160	634	460
FTW 5035V-250	35	29	250	3.535	26.8	33×2	7	102	411	220
FTW 6022.4-320	22.4	14.4	320	6	12.8	16×2	19	53	141	180
FTW 10036V-380	36	26.6	380	7.071	25	23×2	16	149	507	700
FTW 10043.5V-380	43.5	34	380	7.071	31.8	23×2	16	182	660	845
FTW 10070V-500	70	56.5	500	7.071	52.8	35×2	13.5	394	1804	1790

Model number coding

FTW5050 P1 -750L

Model number Accuracy indication symbol (*1) Overall cage length (in mm)

(*1) See **A11-7**.

Raceway

To maximize the performance of the Flat Roller, it is necessary to take into account the hardness, surface roughness and accuracy of the raceway, on which the rollers directly roll, when manufacturing the product. In particular, the hardness significantly affects the service life. Therefore, it is important to take much care in selecting a material and heat treatment method.

[Hardness]

We recommend surface hardness of 58 HRC (\cong 653 HV) or higher. The depth of the hardened layer is determined by the size of the Flat Roller; we recommend approximately 2 mm for general use. If the hardness of the raceway is lower or the raceway cannot be hardened, multiply the load rating by the corresponding hardness factor indicated in Fig. 1 on **A11-6**.

[Material]

The following materials are generally used as suitable for surface hardening through induction-hardening and flame quenching.

- SUJ2 (JIS G 4805: high-carbon chromium bearing steel)
- SK3 to 6 (JIS G 4401: carbon tool steel)
- S55C (JIS G 4051: carbon steel for machine structural use)

If the machine body is a mold, depending on the conditions, a hardened steel plate may not be used and instead, the surface of mold itself may be hardened.

[Surface Roughness]

To achieve smooth motion, the surface should preferably be finished to Ra0.40 or less. If slight wear is allowed in the initial stage, the surface may be finished to approximately Ra0.80.

[Accuracy]

When high accuracy is required, securing a hardened steel plate to the machine body may cause undulation on the raceway. To avoid this, secure the Flat Roller with bolts before grinding the hardened steel plate as with when mounting the product, or tightening it to the machine body before grinding and finishing the raceway, to produce a good result.

Installing the Flat Roller

[Combination of 90° V Surface and Flat Surface]

The Flat Roller can be mounted directly onto the guide surface on the 90° V surface and flat surface. Table1 shows examples of their combinations.

Note) The roller diameter (Da) for model numbers containing symbol V at the end represents the value $\frac{1}{\sqrt{2}}$ times that of types for the same model number with no symbol.

The diameter of the roller to be combined with 90°V surface will be $\frac{1}{\sqrt{2}}$ times that of the roller on the flat surface.

For example, when using model FT4035 (roller diameter: ϕ 4) on the flat surface, use model FTW4030V (roller diameter: ϕ 2.828) on the V surface. Performance of the Flat Roller is significantly affected by the contact state of the upper and lower raceways. You can check the fit before installing the Flat Roller by designing the raceways as indicated in Fig. 1.

Table1 Example of Combinations

90°V surface		Flat surface	
Model No.	Roller diameter Da	Model No.	Roller diameter Da
FTW 4030V	2.828	FT 4030	4
FTW 4030V	2.828	FT 4035	4
FTW 5035V	3.535	FT 5038	5
FTW 5035V	3.535	FT 5043	5
FTW 5045	5	FT 10060V	7.071
FTW 5050	5	FT 10060V	7.071
FTW 10070V	7.071	FT 10080	10

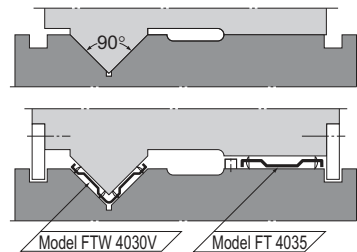

Fig.1 Example of Combinations

[Other Example of Installation]

In locations where a lifting load or an overhang load is applied, the Flat Roller can be installed as shown in Fig.2.

For details on clearance adjustment from the side face, see Example of Clearance Adjustment for the Cross Roller Guide on **A7-29**.

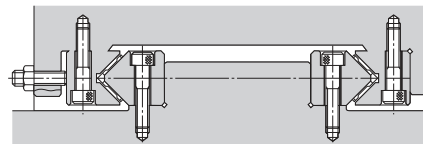

Fig.2 Location where a Lifting Load is Applied

[Determining the Flat Roller Length]

The Flat Roller travels 1/2 of the travel distance of the table in the same direction. Therefore, it is necessary to calculate the stroke length and the Flat Roller length as indicated below.

To keep the Flat Roller under the table, obtain Flat Roller length ℓ_s as follows.

$$\ell_s \leq L_B - L_T$$

The Flat Roller length:

$$\ell = L_T + \frac{\ell_s}{2} = 0.5(L_B + L_T)$$

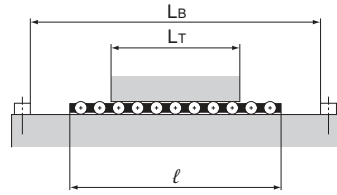

Fig. 3

[Connecting Flat Roller Units]

When it is necessary to join two or more Flat Roller units for an extended period, use a joint plate as shown in Fig. 4 to join them. Indicate the overall length that will actually be used when ordering. Models FT10054, FT10080, and FTW have connecting components already mounted to the main unit, meaning that no joint plate is needed.

Note, however, that Model FT2010 units cannot be joined together.

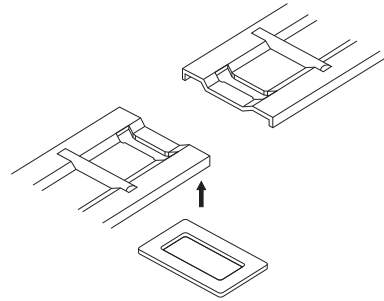
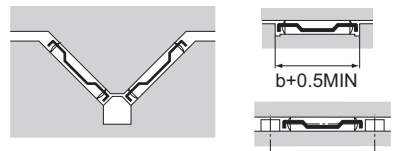

Fig. 4 Connection of Model FT Units

[Guiding the Flat Roller]

To guide model FT or FT-V, follow the instruction as shown in Fig. 5.



For "b", see the specification table.

Fig. 5 Guiding the Flat Roller

Model Number Coding

Model number configurations differ depending on the model features. Refer to the corresponding sample model number configuration.

[Flat Roller]

- Models FT, FT-V, FTW and FTW-V
-

FT5038 P1 -750L

Model No.	Accuracy indication symbol (*1)	Overall cage length (in mm)

(*1) See **A11-7**.

Precautions on Use

Flat Roller

[Handling]

- (1) Do not disassemble the parts. This will result in loss of functionality.
- (2) Take care not to drop or strike the Flat Roller. Doing so may cause injury or damage. Giving an impact to it could also cause damage to its function even if the product looks intact.
- (3) When handling the product, wear protective gloves, safety shoes, etc., as necessary to ensure safety.

[Precautions on Use]

- (1) Prevent foreign material, such as cutting chips or coolant, from entering the product. Failure to do so may cause damage.
- (2) If the product is used in an environment where cutting chips, coolant, corrosive solvents, water, etc., may enter the product, use bellows, covers, etc., to prevent them from entering the product.
- (3) If foreign material such as cutting chips adheres to the product, replenish the lubricant after cleaning the product.
- (4) Do not use the product at temperature of 100°C or higher.
- (5) The Flat Roller cannot be used as a roller conveyor.
- (6) The roller cage may drift as affected by a moment load, vertical mounting, uneven contact and machine vibrations. If the cage drift is not absolutely allowed, using an infinite type LM Guide system is considered.
- (7) Insufficient rigidity or accuracy of mounting members causes the bearing load to concentrate on one point and the bearing performance will drop significantly. Accordingly, give sufficient consideration to the rigidity/accuracy of the housing and base and strength of the fixing bolts.

[Contamination Protection and Lubrication]

- (1) With the Flat Roller, once foreign material enters the raceway due to poor contamination protection, it cannot be removed easily and tends to severely damage the raceway or the Flat Rollers. Therefore, use much care in contamination protection. Normally, for contamination protection of the Flat Roller, a bellows or a telescopic cover that covers the whole sliding surface, as shown in Fig.1, is effective.

- (2) The required quantity of lubricant is much smaller than sliding metals, making the lubrication control easy.

Since the Flat Roller has high lubricant retention, it is suitable for grease lubrication. It is preferable to use lithium-soap group grease No. 2, or slightly viscous sliding surface oil or turbine oil.



(a) Copper cover or telescopic cover

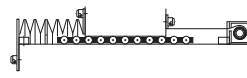

(b) Bellows or roller blind

Fig.1 Contamination Protection Methods

- (3) When lubricating the product, apply grease directly on the raceway and give several break-in strokes.
- (4) Do not mix different lubricants. Mixing greases using the same type of thickening agent may still cause adverse interaction between the two greases if they use different additives, etc.

Precautions on Use

- (5) Micro-strokes tend to obstruct oil film to form on the raceway in contact with the rolling element, and may lead to fretting corrosion. Take consideration using grease offering excellent fretting prevention. Accordingly, use grease offering excellent fretting toughness. It is also recommended that a long-stroke movement be made on a regular basis to make sure oil film is formed between the raceway and rolling element.
- (6) When using the product in locations exposed to constant vibrations or in special environments such as clean rooms, vacuum and low/high temperature, use the grease appropriate for the specification/environment.
- (7) The consistency of grease changes according to the temperature. Take note that the slide resistance of the Flat Roller also changes as the consistency of grease changes.
- (8) After lubrication, the slide resistance of the Flat Roller may increase due to the agitation resistance of grease. Be sure to perform a break-in to let the grease spread fully, before operating the machine.
- (9) Excess grease may scatter immediately after lubrication, so wipe off scattered grease as necessary.
- (10) The properties of grease deteriorate and its lubrication performance drops over time, so grease must be checked and added properly according to the use frequency of the machine.
- (11) The greasing interval varies depending on the use condition and service environment. Set the final lubrication interval/amount based on the actual machine.

[Attaching the Stopper]

Although the Flat Roller performs extremely accurate motion, it may cause a traveling error due to uneven load distribution or non-uniform stop. Therefore, we recommend attaching a stopper on the end of the base or the table.

[Chamfering the End Face of the Table]

If the Flat Roller is longer than the overall table length, finely chamfer the end face of the table so that the rollers are easily fed to the table.

[Mounting Precision]

To maximize the performance of the Flat Roller, it is necessary to distribute the load as evenly as possible when mounting the product. Fig.2 For the allowable tilt as shown in , we recommend 0.1 mm or less against $1,000 \text{ mm}$.

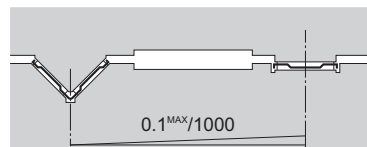

Fig.2 Mounting Precision

[Storage]

When storing the Flat Roller, enclose it in a package designated by THK and store it in a room in a horizontal orientation while avoiding high temperature, low temperature and high humidity.

[Disposal]

Dispose of the product properly as industrial waste.

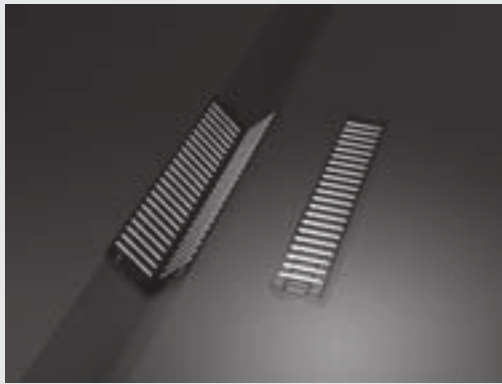

Flat Roller

THK General Catalog

B Support Book

Features and Types	B11-2
Features of the Flat Roller	B11-2
• Structure and Features	B11-2
Types of the Flat Roller	B11-3
• Types and Features	B11-3
Point of Selection	B11-4
Rated Load and Nominal Life	B11-4
Mounting Procedure	B11-7
Model No.	B11-9
• Model Number Coding	B11-9
Precautions on Use	B11-10

A Product Descriptions (Separate)

Features and Types	A11-2
Features of the Flat Roller	A11-2
• Structure and Features	A11-2
Types of the Flat Roller	A11-3
• Types and Features	A11-3
Point of Selection	A11-4
Rated Load and Nominal Life	A11-4
Accuracy Standards	A11-7
Dimensional Drawing, Dimensional Table	
Model FT	A11-8
Model FTW	A11-9
Point of Design	A11-10
Raceway	A11-10
Installing the Flat Roller	A11-11
Model No.	A11-13
• Model Number Coding	A11-13
Precautions on Use	A11-14

Features of the Flat Roller

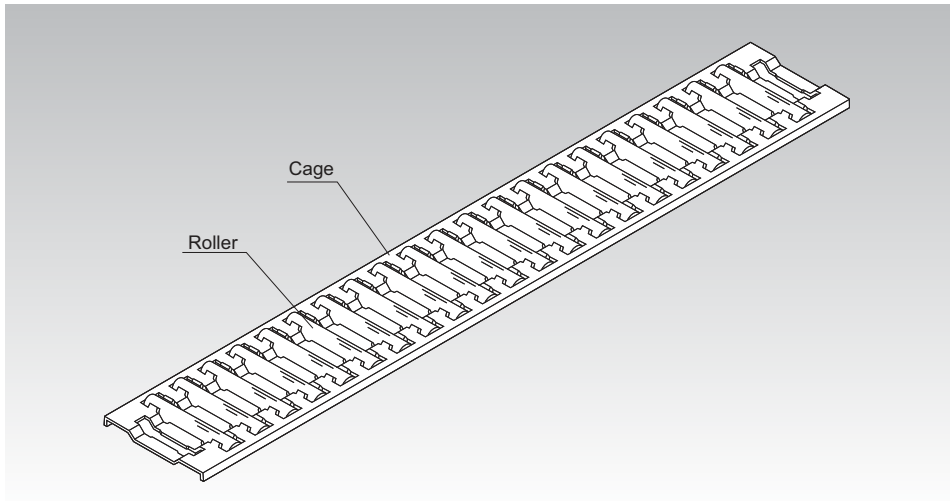

Fig.1 Structure of LM Flat Roller Model FT

Structure and Features

For the Flat Roller, precision rollers compliant with JIS B1506 are installed in a thin, steel plate cage, which is formed into an "M" shape for improved rigidity and light weight. The pockets of the cage are designed to prevent the rollers from falling out. The Flat Roller is sandwiched between two raceways, so it moves half the distance traveled by the table. For example, if the table moves 500 mm, the Flat Roller moves 250 mm in the same direction.

The Flat Roller is optimal for large machine tools such as planer, horizontal milling machines and cylindrical grinding machines, and for locations requiring high accuracy such as surface grinding machines, cylindrical grinder and optic measuring machines.

[Large Load Capacity]

Since rollers are installed in short pitches, the Flat Roller has a large load capacity, and depending on the conditions, it can be used on the raceway of a mold that is little hardened. In addition, the deflection rigidity of the table is almost the same as that of a sliding surface.

Features and Types

Types of the Flat Roller

[Combined Accuracy of 90° V Surface and Flat Surface Supported as Standard]

The Flat Roller is designed so that it can be mounted on the 90° V-flat sliding surface, which is the most common configuration among narrow guide types of tables and saddles of machinery. It allows the product to be used without major design change.

[Lowest Friction among Roller Type LM Systems]

Since the rollers are evenly held in a light, rigid cage, friction between rollers is eliminated and skewing of the rollers is minimized. As a result, a small friction coefficient ($\mu = 0.001$ to 0.0025) is achieved, and stick-slip, which is problematic with sliding surfaces, does not occur.

[Instant Connection of the Cage]

When installing the Flat Roller in a large machine, it can easily be connected on the bed. This allows the Flat Roller to be installed even with the longest type.

Types of the Flat Roller

Types and Features

Model FT/FT-V

These models have a single row of rollers and are mainly used on the flat surface.

Specification Table⇒ [A 11-8](#)

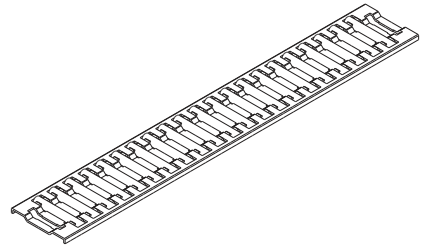

Models FT/FT-V

Model FTW/FTW-V

These models have two or more rows of rollers, and their cages are shaped to bend at 90°. Each model uses rollers with a diameter 0.7071 times greater than that of the rollers on the flat surface so that model FT or FT-V can be mounted on the 90° V surface at the same height if model FT or FT-V is used on the flat surface.

Specification Table⇒ [A 11-9](#)

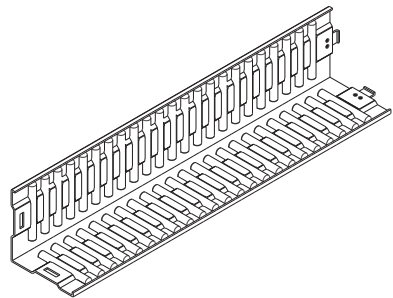

Models FTW/FTW-V

Rated Load and Nominal Life

[Static Safety Factor f_s]

The Flat Roller may receive an unexpected external force while it is stationary or operative due to the generation of an inertia caused by vibrations and impact or start and stop. It is necessary to consider a static safety factor against such a working load.

$$f_s = \frac{f_H \cdot f_T \cdot f_C \cdot C_0}{P_c}$$

- f_s : Static safety factor
 f_H : Hardness factor (see Fig.1 on [B11-6](#))
 f_T : Temperature factor (see Fig.2 on [B11-6](#))
 f_C : Contact factor
 (see [Load Rating] and [Nominal Life] on [B11-5](#))
 C_0 : Basic static load rating (kN)
 P_c : Calculated radial load (kN)

● Reference Value of Static Safety Factor

The static safety factors indicated in Table1 are the lower limits of reference values in the respective conditions.

Table1 Reference Value of Static Safety Factors (f_s)

Machine using the LM system	Load conditions	Lower limit of f_s
General industrial machinery	Without vibration or impact	1 to 1.3
	With vibration or impact	2 to 3
Machine tool	Without vibration or impact	1 to 1.5
	With vibration or impact	2.5 to 7

Point of Selection

Rated Load and Nominal Life

[Load Rating]

The rated loads shown in the specification tables represent the rated loads with a unit length (ℓ) in the directions indicated in the figure below.

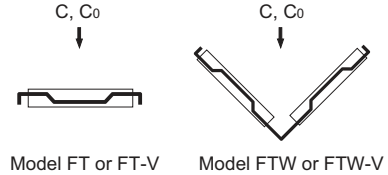

If the length of the Flat Roller in the effective load range differs from the unit length (ℓ), approximate rated loads (C_{ℓ} and $C_{0\ell}$) can be obtained using the following equation.

$$C_{\ell} = \left(\frac{\ell_0}{\ell} \right)^{\frac{3}{4}} \times C$$

$$C_{0\ell} = \frac{\ell_0}{\ell} \cdot C_0$$

- C_{ℓ} : Basic dynamic load rating
in the effective load range (kN)
- ℓ_0 : Length in effective load range (mm)
- ℓ : Unit length
(see the specification table) (mm)
- $C_{0\ell}$: Basic static load rating
in the effective load range (kN)
- C : Basic dynamic load rating (kN)
- C_0 : Basic static load rating (kN)

Note) Note that if the hardness of the raceway is lower than 58 HRC, the rated loads will be decreased. (See Fig.1 on [11-6](#).)

[Nominal Life]

When the basic dynamic load rating (C_{ℓ}) of the Flat Roller in the effective load range has been obtained from the equation above, the nominal life is obtained using the following equation.

$$L = \left(\frac{f_H \cdot f_c \cdot f_T}{f_W} \cdot \frac{C_{\ell}}{P_C} \right)^{\frac{10}{3}} \times 100$$

- L : Nominal life (km)
(The total number of revolutions that 90% of a group of identical Flat Roller units independently operating under the same conditions can achieve without showing flaking)
- C_{ℓ} : Basic dynamic load rating (kN)
- P_C : Calculated radial load (kN)
- f_H : Hardness factor (see Fig.1 [11-6](#))
- f_T : Temperature factor (see Fig.2 [11-6](#))
- f_W : Load factor (see Table2 [11-6](#))
- f_c : Contact factor^{Note)}

Note) Contact factor is determined according to the contact state of the two planes between which the rollers travel. If the contact ratio between the two planes is 50%, set the contact factor as $f_c = 0.5$ for safety's sake.

[Calculating the Service Life Time]

When the nominal life (L) has been obtained, if the stroke length and the number of reciprocations per minute are constant, the service life time is obtained using the following equation.

$$L_h = \frac{L \times 10^6}{2 \times \ell_s \times n_1 \times 60}$$

L_h : Service life time (h)
 ℓ_s : Stroke length (mm)
 n_1 : Number of reciprocations per minute (min^{-1})

● f_H : Hardness Factor

To maximize the load capacity of the LM system, the hardness of the raceways needs to be between 58 to 64 HRC. If the hardness is lower than this range, the basic dynamic load rating and the basic static load rating decrease. Therefore, it is necessary to multiply each rating by the respective hardness factor (f_H).

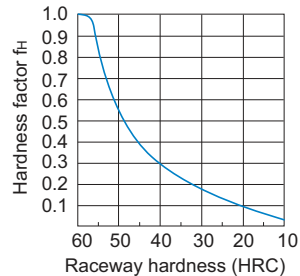

Fig. 1 Hardness Factor (f_H)

● f_T : Temperature Factor

If the temperature of the environment surrounding the operating Flat Roller exceeds 100°C, take into account the adverse effect of the high temperature and multiply the basic load ratings by the temperature factor indicated in Fig. 2.

Note) If the environment temperature exceeds 100°C, contact THK.

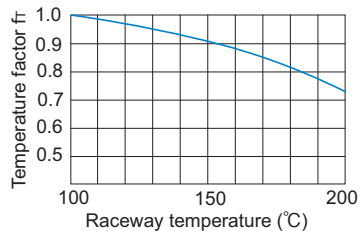

Fig. 2 Temperature Factor (f_T)

● f_w : Load Factor

In general, reciprocating machines tend to involve vibrations or impact during operation. It is extremely difficult to accurately determine vibrations generated during high-speed operation and impact during frequent start and stop. Therefore, when the actual load applied cannot be obtained, or when speed and impact have a significant influence, divide the basic load rating (C or C_0), by the corresponding load factor in Table 2, of empirically obtained data.

Table 2 Load Factor (f_w)

Vibrations/impact	Speed(V)	f_w
Faint	Very low $V \leq 0.25\text{m/s}$	1 to 1.2
Weak	Slow $0.25 < V \leq 1\text{m/s}$	1.2 to 1.5
Medium	Medium $1 < V \leq 2\text{m/s}$	1.5 to 2
Strong	High $V > 2\text{m/s}$	2 to 3.5

Mounting Procedure

Flat Roller

[Combination of 90° V Surface and Flat Surface]

The Flat Roller can be mounted directly onto the guide surface on the 90° V surface and flat surface. Table1 shows examples of their combinations.

Note) The roller diameter (Da) for model numbers containing symbol V at the end represents the value $\frac{1}{\sqrt{2}}$ times that of types for the same model number with no symbol.

The diameter of the roller to be combined with 90° V surface will be $\frac{1}{\sqrt{2}}$ times that of the roller on the flat surface.

For example, when using model FT4035 (roller diameter: ϕ 4) on the flat surface, use model FTW4030V (roller diameter: ϕ 2.828) on the V surface. Performance of the Flat Roller is significantly affected by the contact state of the upper and lower raceways. You can check the fit before installing the Flat Roller by designing the raceways as indicated in Fig. 1.

Table1 Example of Combinations

90°V surface		Flat surface	
Model No.	Roller diameter Da	Model No.	Roller diameter Da
FTW 4030V	2.828	FT 4030	4
FTW 4030V	2.828	FT 4035	4
FTW 5035V	3.535	FT 5038	5
FTW 5035V	3.535	FT 5043	5
FTW 5045	5	FT 10060V	7.071
FTW 5050	5	FT 10060V	7.071
FTW 10070V	7.071	FT 10080	10

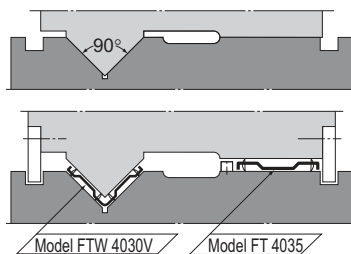

Fig.1 Example of Combinations

[Other Example of Installation]

In locations where a lifting load or an overhang load is applied, the Flat Roller can be installed as shown in Fig.2.

For details on clearance adjustment from the side face, see Example of Clearance Adjustment for the Cross Roller Guide on **A7-29**.

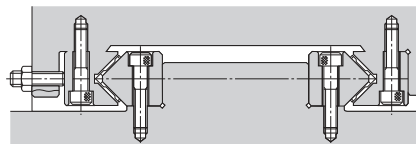

Fig.2 Location where a Lifting Load is Applied

[Determining the Flat Roller Length]

The Flat Roller travels 1/2 of the travel distance of the table in the same direction. Therefore, it is necessary to calculate the stroke length and the Flat Roller length as indicated below.

To keep the Flat Roller under the table, obtain Flat Roller length ℓ_s as follows.

$$\ell_s \leq L_B - L_T$$

The Flat Roller length:

$$\ell = L_T + \frac{\ell_s}{2} = 0.5(L_B + L_T)$$

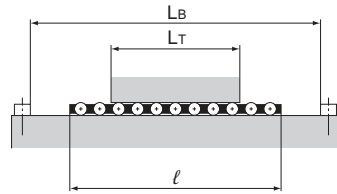

Fig. 3

[Connecting Flat Roller Units]

When it is necessary to join two or more Flat Roller units for an extended period, use a joint plate as shown in Fig. 4 to join them. Indicate the overall length that will actually be used when ordering. Models FT10054, FT10080, and FTW have connecting components already mounted to the main unit, meaning that no joint plate is needed.

Note, however, that Model FT2010 units cannot be joined together.

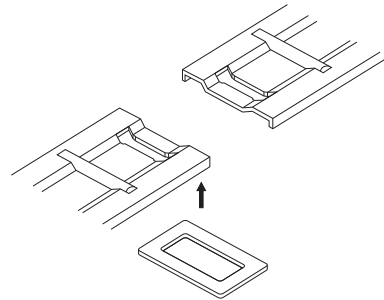
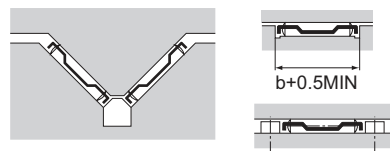

Fig. 4 Connection of Model FT Units

[Guiding the Flat Roller]

To guide model FT or FT-V, follow the instruction as shown in Fig. 5.



For "b", see the specification table.

Fig. 5 Guiding the Flat Roller

Model Number Coding

Model number configurations differ depending on the model features. Refer to the corresponding sample model number configuration.

[Flat Roller]

- Models FT, FT-V, FTW and FTW-V
-

FT5038 P1 -750L

Model No.	Accuracy indication symbol (*1)	Overall cage length (in mm)

(*1) See **A11-7**.

Precautions on Use

Flat Roller

[Handling]

- (1) Do not disassemble the parts. This will result in loss of functionality.
- (2) Take care not to drop or strike the Flat Roller. Doing so may cause injury or damage. Giving an impact to it could also cause damage to its function even if the product looks intact.
- (3) When handling the product, wear protective gloves, safety shoes, etc., as necessary to ensure safety.

[Precautions on Use]

- (1) Prevent foreign material, such as cutting chips or coolant, from entering the product. Failure to do so may cause damage.
- (2) If the product is used in an environment where cutting chips, coolant, corrosive solvents, water, etc., may enter the product, use bellows, covers, etc., to prevent them from entering the product.
- (3) If foreign material such as cutting chips adheres to the product, replenish the lubricant after cleaning the product.
- (4) Do not use the product at temperature of 100°C or higher.
- (5) The Flat Roller cannot be used as a roller conveyor.
- (6) The roller cage may drift as affected by a moment load, vertical mounting, uneven contact and machine vibrations. If the cage drift is not absolutely allowed, using an infinite type LM Guide system is considered.
- (7) Insufficient rigidity or accuracy of mounting members causes the bearing load to concentrate on one point and the bearing performance will drop significantly. Accordingly, give sufficient consideration to the rigidity/accuracy of the housing and base and strength of the fixing bolts.

[Contamination Protection and Lubrication]

- (1) With the Flat Roller, once foreign material enters the raceway due to poor contamination protection, it cannot be removed easily and tends to severely damage the raceway or the Flat Rollers. Therefore, use much care in contamination protection. Normally, for contamination protection of the Flat Roller, a bellows or a telescopic cover that covers the whole sliding surface, as shown in Fig.1, is effective.

- (2) The required quantity of lubricant is much smaller than sliding metals, making the lubrication control easy.

Since the Flat Roller has high lubricant retention, it is suitable for grease lubrication. It is preferable to use lithium-soap group grease No. 2, or slightly viscous sliding surface oil or turbine oil.



(a) Copper cover or telescopic cover

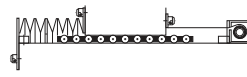

(b) Bellows or roller blind

Fig.1 Contamination Protection Methods

- (3) When lubricating the product, apply grease directly on the raceway and give several break-in strokes.
- (4) Do not mix different lubricants. Mixing greases using the same type of thickening agent may still cause adverse interaction between the two greases if they use different additives, etc.

Precautions on Use

- (5) Micro-strokes tend to obstruct oil film to form on the raceway in contact with the rolling element, and may lead to fretting corrosion. Take consideration using grease offering excellent fretting prevention. Accordingly, use grease offering excellent fretting toughness. It is also recommended that a long-stroke movement be made on a regular basis to make sure oil film is formed between the raceway and rolling element.
- (6) When using the product in locations exposed to constant vibrations or in special environments such as clean rooms, vacuum and low/high temperature, use the grease appropriate for the specification/environment.
- (7) The consistency of grease changes according to the temperature. Take note that the slide resistance of the Flat Roller also changes as the consistency of grease changes.
- (8) After lubrication, the slide resistance of the Flat Roller may increase due to the agitation resistance of grease. Be sure to perform a break-in to let the grease spread fully, before operating the machine.
- (9) Excess grease may scatter immediately after lubrication, so wipe off scattered grease as necessary.
- (10) The properties of grease deteriorate and its lubrication performance drops over time, so grease must be checked and added properly according to the use frequency of the machine.
- (11) The greasing interval varies depending on the use condition and service environment. Set the final lubrication interval/amount based on the actual machine.

[Attaching the Stopper]

Although the Flat Roller performs extremely accurate motion, it may cause a traveling error due to uneven load distribution or non-uniform stop. Therefore, we recommend attaching a stopper on the end of the base or the table.

[Chamfering the End Face of the Table]

If the Flat Roller is longer than the overall table length, finely chamfer the end face of the table so that the rollers are easily fed to the table.

[Mounting Precision]

To maximize the performance of the Flat Roller, it is necessary to distribute the load as evenly as possible when mounting the product. Fig.2 For the allowable tilt as shown in , we recommend 0.1 mm or less against $1,000 \text{ mm}$.

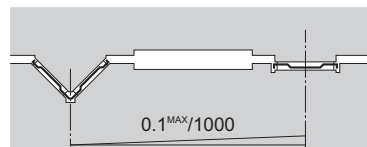

Fig.2 Mounting Precision

[Storage]

When storing the Flat Roller, enclose it in a package designated by THK and store it in a room in a horizontal orientation while avoiding high temperature, low temperature and high humidity.

[Disposal]

Dispose of the product properly as industrial waste.

