



Rod End

THK General Catalog

A Product Descriptions

Features and Types	A23-2
Features of the Rod End	A23-2
• Features	A23-2
Types of the Rod End	A23-3
• Types and Features	A23-3
Point of Selection	A23-5
Selecting a Rod End	A23-5
Dimensional Drawing, Dimensional Table	
Model PHS (Female Threading Type) ..	A23-6
Model NHS-T (No Lubrication Type) ..	A23-8
Model POS (Male Thread Type)	A23-10
Model NOS-T (No Lubrication, Male Thread Type) ..	A23-12
Model PB (Standard Type)	A23-14
Point of Design	A23-15
Permissible Tilt Angles	A23-15
Installation	A23-15
Model No.	A23-16
• Model Number Coding	A23-16
Precautions on Use	A23-17

B Support Book (Separate)

Features and Types	B23-2
Features of the Rod End	B23-2
• Features	B23-2
Types of the Rod End	B23-3
• Types and Features	B23-3
Point of Selection	B23-5
Selecting a Rod End	B23-5
Installation	B23-6
Installation	B23-6
Model No.	B23-7
• Model Number Coding	B23-7
Precautions on Use	B23-8

Features of the Rod End

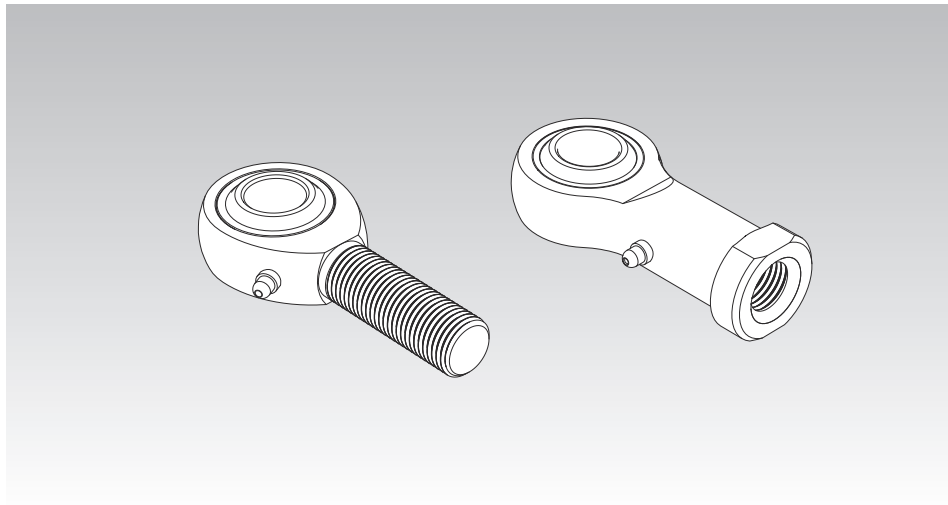

Features

The Rod End is a self-aligning plain bearing that uses a spherical inner ring which has the same level of accuracy and hardness as bearing steel balls. With the combination of a spherical inner ring whose sliding surface is mirror-finished and a rationally designed holder, the Rod End ensures play-free, extremely smooth rotation and oscillation.

Types of the Rod End

Types and Features

Type Provided with a Female Threading - Model PHS

Specification Table⇒ [A 23-6](#)

With model PHS, a copper alloy with high conformability is inserted between the chromate treated steel holder and the spherical inner ring, in which only the circumference of the spherical area is hard chrome plated. This structure ensures high rigidity, high wear resistance and high corrosion resistance.

The grease nipple on the holder allows grease to be applied to the sliding surface as necessary.

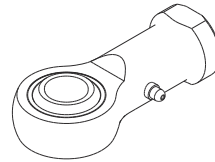

Model PHS

No Lubrication Type - Model NHS-T

Specification Table⇒ [A 23-8](#)

This no lubrication rod end uses self-lubricating synthetic resin formed between the steel holder and the spherical inner ring.

Since the clearance on the sliding surface is minimized, an accurate link motion is achieved.

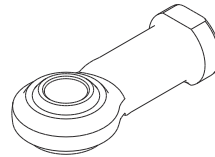

Model NHS-T

Male thread Type - Model POS

Specification Table⇒ [A 23-10](#)

This model is a highly rigid rod end that is basically the same as the female threading type model PHS, but has a male thread on the holder end.

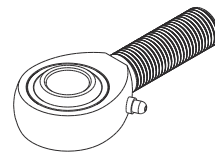

Model POS

No Lubrication, Male thread Type - Model NOS-T

Specification Table⇒ [A 23-12](#)

This model is a no lubrication rod end that is basically the same as the female threading type model NHS-T, but has a male thread on the holder end.

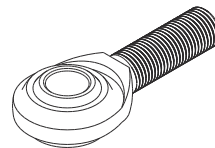

Model NOS-T

Standard Type - Model PB

With model PB, a copper alloy with high conformability is inserted between the steel outer ring and the spherical inner ring, in which only the spherical area is hard chrome plated. This structure makes this model a highly rigid Spherical Plain Bearing with high corrosion resistance and high wear resistance.

The oil groove and the greasing hole on the outer ring allow grease to be applied to the sliding surface as necessary.

Specification Table⇒ **A23-14**

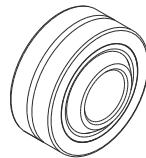

Model PB

Selecting a Rod End

[Permissible Load P]

The static load capacity (C_s) indicated in the specification tables, is presented as a guide for the mechanical strength of the Rod End. Select a bearing while taking into account the safety factor (f_s) indicated in Table1 according to the type of the load.

Table1 Safety Factor (f_s)

Type of load	Lower limit of f_s
Constant load in a constant direction	2 to 3
Fluctuating load in a constant direction	3 to 5
Load in varying directions	5 to 8

According to the type of load, select a bearing that satisfies the following equation from a mechanical strength's viewpoint.

$$P \leq \frac{C_s}{f_s} \quad \dots\dots(1)$$

- P : Permissible Load (N)
 C_s : Static load capacity (N)
 f_s : Safety factor (see Table1)

[Dynamic Load Capacity C_d]

The dynamic load capacity refers to the upper limit of load that the spherical area can receive without showing seizure while the Rod End is rotating or oscillating. The dynamic load capacity is obtained from the following approximation formula using the static load capacity (C_s) ^(note 1) indicated in the specification table.

$$C_d = \frac{C_s}{\sqrt[3]{n}} \quad \dots\dots(2)$$

- C_d : Dynamic load capacity (N)
 C_s : Static load capacity (N)
 n : Revolutions per minute (min^{-1})

The selected bearing must meet both the permissible load obtained from equation (1) and the dynamic load capacity obtained from equation (2).

Note1) Static load capacity (C_s) refers to the value obtained by multiplying the projected area on the spherical section by the permissible surface pressure, and is used to obtain the dynamic load capacity.

Model PHS (Female Threading Type)

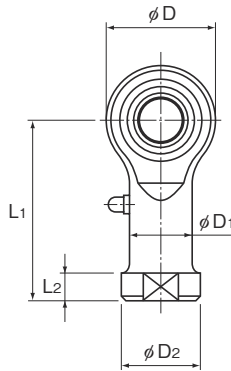

Model No.	Outer dimensions			Threaded S ₁ JIS Class 2	Holder Dimensions			
	Length L	Diameter D	Width B ₁ 0 -0.1		W 0 -0.2	D ₁	D ₂	B ±0.1
PHS 5	35	16	8	M5×0.8	9	9	11	6
PHS 6	39	18	9	M6×1	11	10	13	6.75
PHS 8	47	22	12	M8×1.25	14	12.5	16	9
PHS 10	56	26	14	M10×1.5	17	15	19	10.5
PHS 12	65	30	16	M12×1.75	19	17.5	22	12
PHS 14	74	34	19	M14×2	22	20	25	13.5
PHS 16	83	38	21	M16×2	22	22	27	15
PHS 18	92	42	23	M18×1.5	27	25	31	16.5
PHS 20	100	46	25	M20×1.5	30	27.5	34	18
PHS 22	109	50	28	M22×1.5	32	30	37	20
PHS 25	124	60	31	M24×2	36	33.5	42	22
PHS 30	145	70	37	M30×2	41	40	50	25

[Material]

Holder : S35C (Chromate treatment)

Spherical inner ring: SUJ2, 58 HRC or higher

(Hard chrome plated except for the inner surface of the inner ring)

Bush : copper alloy

[Fitting with the Shaft]

Condition	Dimensional tolerance of the shaft
Normal load	h7
Indeterminate load	p6

Model number coding

PHS10 L

Model number | Left-hand thread

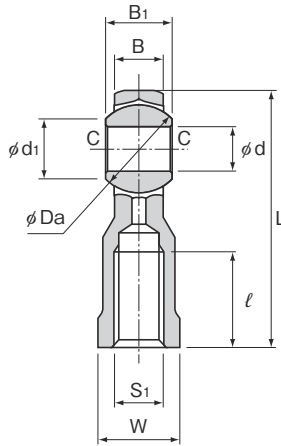

Unit: mm

				Grease nipple	Spherical inner ring dimensions				Permissible tilt angles			Static applied load Radial	Mass
L ₁	L ₂	ℓ	d		Ball diameter Da mm (inch)	d ₁	C	α ₁ °	α ₂ °	α ₃ °	C _s		
			H7								N	g	
27	4	14	PB107	5	11.112(7/16)	7.7	0.3	8	13	30	5590	16.5	
30	5	14		6	12.7(1/2)	9	0.3	8	13	30	6860	25	
36	5	17		8	15.875(5/8)	10.4	0.5	8	14	25	9800	43	
43	6.5	21		10	19.05(3/4)	12.9	0.5	8	14	25	13200	72	
50	6.5	24		12	22.225(7/8)	15.4	0.5	8	13	25	16700	107	
57	8	27		14	25.4(1)	16.9	0.7	10	16	24	20600	160	
64	8	33		16	28.575(1 1/8)	19.4	0.7	9	15	24	25000	210	
71	10	36		18	31.75(1 1/4)	21.9	0.7	9	15	24	29400	295	
77	10	40		20	34.925(1 3/8)	24.4	0.7	9	15	24	34300	380	
84	12	43		22	38.1(1 1/2)	25.8	0.7	10	15	23	41200	490	
94	12	48		A-M6F	25	42.862(1 11/16)	29.6	0.8	9	15	23	72500	750
110	15	56			30	50.8(2)	34.8	0.8	10	17	23	92200	1130

[Clearance]

Unit: mm

Radial clearance	0.035 or less
Axial clearance	0.1 or less

[Lubrication]

Apply lubricant before using the product. The holder has a greasing hole and an oil groove; they allow grease to be replenished through the grease nipple as necessary.

[Identification of Left-hand Thread]

If the female threading is left-hand, symbol "L" is added. The actual product is marked with symbol "L" on the holder.

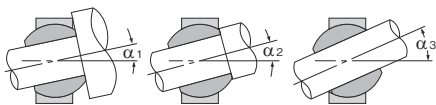

Permissible Tilt Angles

Model NHS-T (No Lubrication Type)

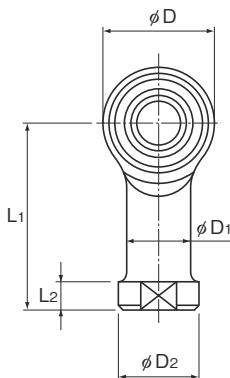

Model No.	Outer dimensions			Threaded S ₁ JIS Class 2	Holder Dimensions			
	Length L	Diameter D	Width B ₁ 0 -0.1		W 0 -0.2	D ₁	D ₂	B +0.1 -0.4
NHS 3T	27	12	6	M3×0.5	7	6.5	8	4.5
NHS 4T	31	14	7	M4×0.7	8	8	9.5	5.3
NHS 5T	35	16	8	M5×0.8	9	9	11	6
NHS 6T	39	18	9	M6×1	11	10	13	6.75
NHS 8T	47	22	12	M8×1.25	14	12.5	16	9
NHS 10T	56	26	14	M10×1.5	17	15	19	10.5
NHS 12T	65	30	16	M12×1.75	19	17.5	22	12
NHS 14T	74	34	19	M14×2	22	20	25	13.5
NHS 16T	83	38	21	M16×2	22	22	27	15
NHS 18T	92	42	23	M18×1.5	27	25	31	16.5
NHS 20T	100	46	25	M20×1.5	30	27.5	34	18
NHS 22T	109	50	28	M22×1.5	32	30	37	20

[Material]

Holder : S35C (Chromate treatment)
 For NHS3T and NHS4T, S20C
 Spherical inner ring: SUJ2, 58 HRC or higher
 (Hard chrome plated except for the
 inner surface of the inner ring)

Bush : Self-lubricating synthetic resin

[Fitting with the Shaft]

Condition	Dimensional tolerance of the shaft
Normal load	h7
Indeterminate load	p6

Model number coding

NHS10T L

Model number

Left-hand thread

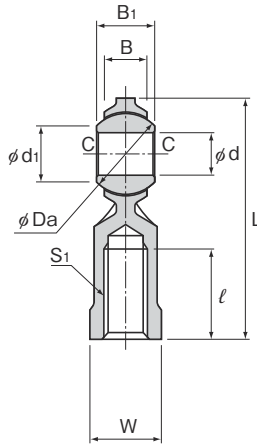

Unit: mm

				Spherical inner ring dimensions				Permissible tilt angles			Static applied load Radial	Mass
L ₁	L ₂	ℓ	d	Ball diameter Da mm (inch)	d ₁	C	α ₁ °	α ₂ °	α ₃ °	C _s	g	
			H7							N		
21	3	10	3	9.525 ^(9/8)	7.4	0.3	8	10	42	1570	6.5	
24	4	12	4	10.319 ^(13/32)	7.6	0.3	9	11	35	2250	10	
27	4	14	5	11.112 ^(7/16)	7.7	0.3	8	13	30	3920	16.5	
30	5	14	6	12.7 ^(1/2)	9	0.3	8	13	30	5000	25	
36	5	17	8	15.875 ^(5/8)	10.4	0.5	8	14	25	7450	43	
43	6.5	21	10	19.05 ^(3/4)	12.9	0.5	8	14	25	9410	72	
50	6.5	24	12	22.225 ^(7/8)	15.4	0.5	8	13	25	11000	107	
57	8	27	14	25.4 ⁽¹⁾	16.9	0.7	10	16	24	15200	160	
64	8	33	16	28.575 ^(1 1/8)	19.4	0.7	9	15	24	20200	210	
71	10	36	18	31.75 ^(1 1/4)	21.9	0.7	9	15	24	25200	295	
77	10	40	20	34.925 ^(1 3/8)	24.4	0.7	9	15	24	27800	380	
84	12	43	22	38.1 ^(1 1/2)	25.8	0.7	10	15	23	35900	490	

[Clearance]

Unit: mm

Radial clearance	0.035 or less
Axial clearance	0.1 or less

[Initial Lubrication]

This model can be used without lubrication. However, if desiring to provide initial lubrication, apply oil or grease to the spherical area.

[Identification of Left-hand Thread]

If the female threading is left-hand, symbol "L" is added. The actual product is marked with symbol "L" on the holder.

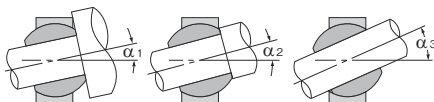

Permissible Tilt Angles

Model POS (Male Thread Type)

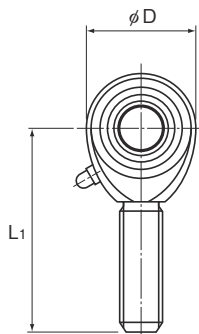

Model No.	Outer dimensions			Threaded S_1 JIS Class 2	Holder Dimensions	
	Length L	Diameter D	Width B_1 0 -0.1		B ± 0.1	L_1
POS 5	41	16	8	M5×0.8	6	33
POS 6	45	18	9	M6×1	6.75	36
POS 8	53	22	12	M8×1.25	9	42
POS 10	61	26	14	M10×1.5	10.5	48
POS 12	69	30	16	M12×1.75	12	54
POS 14	77	34	19	M14×2	13.5	60
POS 16	85	38	21	M16×2	15	66
POS 18	93	42	23	M18×1.5	16.5	72
POS 20	101	46	25	M20×1.5	18	78
POS 22	109	50	28	M22×1.5	20	84
POS 25	124	60	31	M24×2	22	94
POS 30	145	70	37	M30×2	25	110

[Material]

Holder : S35C (Chromate treatment)

Spherical inner ring : SUJ2, 58 HRC or higher

(Hard chrome plated except for the inner surface of the inner ring)

Bush : copper alloy

[Fitting with the Shaft]

Condition	Dimensional tolerance of the shaft
Normal load	h7
Indeterminate load	p6

Model number coding

POS10 L

Model number |

Left-hand thread

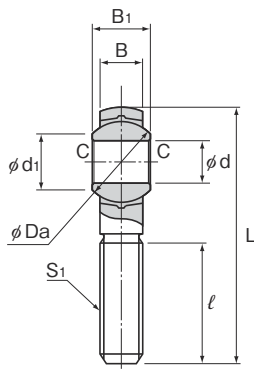

Unit: mm

	l	Grease nipple (Greasing hole)	Spherical inner ring dimensions				Permissible tilt angles			Static applied load Radial	Mass
			d H7	Ball diameter Da mm (inch)	d ₁	C	α_1°	α_2°	α_3°	C _s N	g
	20	($\phi 1.5$)	5	11.112(⁷ / ₁₆)	7.7	0.3	8	13	30	3430	12.5
	22		6	12.7(¹ / ₂)	9	0.3	8	13	30	4900	19
	25	PB107	8	15.875(⁵ / ₈)	10.4	0.5	8	14	25	6860	32
	29		10	19.05(³ / ₄)	12.9	0.5	8	14	25	10800	54
	33		12	22.225(⁷ / ₈)	15.4	0.5	8	13	25	16700	85
	36		14	25.4(1)	16.9	0.7	10	16	24	20600	126
	40		16	28.575(¹ / ₈)	19.4	0.7	9	15	24	25000	185
	44		18	31.75(¹ / ₄)	21.9	0.7	9	15	24	29400	260
	47		20	34.925(¹ / ₈)	24.4	0.7	9	15	24	34300	340
	51		22	38.1(¹ / ₂)	25.8	0.7	10	15	23	41200	435
	57	A-M6F	25	42.862(¹ / ₁₆)	29.6	0.8	9	15	23	72500	650
	66		30	50.8(2)	34.8	0.8	10	17	23	92200	1070

[Clearance]

Unit: mm

Radial clearance	0.035 or less
Axial clearance	0.1 or less

[Lubrication]

Apply lubricant before using the product. The holder has a greasing hole and an oil groove; they allow grease to be replenished through the grease nipple as necessary. To lubricate the product, replenish grease from the holder greasing hole for models POS5 and 6, or from the grease nipple for other models.

[Identification of Left-hand Thread]

If the male thread is left-hand, symbol "L" is added. The actual product is marked with symbol "L" on the holder.

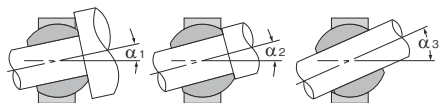

Permissible Tilt Angles

Model NOS-T (No Lubrication, Male Thread Type)

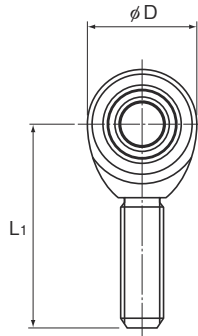

Model No.	Outer dimensions			Threaded S ₁ JIS Class 2	Holder Dimensions	
	Length L	Diameter D	Width B ₁ 0 -0.1		B +0.1 -0.4	L ₁
NOS 3T	33	12	6	M3×0.5	4.5	27
NOS 4T	37	14	7	M4×0.7	5.3	30
NOS 5T	41	16	8	M5×0.8	6	33
NOS 6T	45	18	9	M6×1	6.75	36
NOS 8T	53	22	12	M8×1.25	9	42
NOS 10T	61	26	14	M10×1.5	10.5	48
NOS 12T	69	30	16	M12×1.75	12	54
NOS 14T	77	34	19	M14×2	13.5	60
NOS 16T	85	38	21	M16×2	15	66
NOS 18T	93	42	23	M18×1.5	16.5	72
NOS 20T	101	46	25	M20×1.5	18	78
NOS 22T	109	50	28	M22×1.5	20	84

[Material]

Holder : S35C (Chromate treatment)
For NOS3T and NOS4T, S20C
Spherical inner ring: SUJ2, 58 HRC or higher
(Hard chrome plated except for the inner surface of the inner ring)
Bush : Self-lubricating synthetic resin

[Fitting with the Shaft]

Condition	Dimensional tolerance of the shaft
Normal load	h7
Indeterminate load	p6

Model number coding

NOS10T L

Model number

Left-hand thread

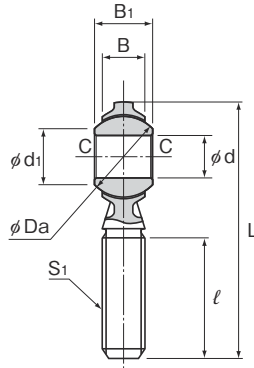

Unit: mm

	Spherical inner ring dimensions				Permissible tilt angles			Static applied load Radial Cs N	Mass g	
	l	d H7	Ball diameter Da mm (inch)	d_1	C	α_1°	α_2°			α_3°
15	3	3	9.525(³ / ₈)	7.4	0.3	8	10	42	1570	4.5
17	4	4	10.319(¹³ / ₃₂)	7.6	0.3	9	11	35	2250	7
20	5	5	11.112(⁷ / ₁₆)	7.7	0.3	8	13	30	3430	12.5
22	6	6	12.7(¹ / ₂)	9	0.3	8	13	30	4900	19
25	8	8	15.875(⁵ / ₈)	10.4	0.5	8	14	25	6860	32
29	10	10	19.05(³ / ₄)	12.9	0.5	8	14	25	9410	54
33	12	12	22.225(⁷ / ₈)	15.4	0.5	8	13	25	11000	85
36	14	14	25.4(1)	16.9	0.7	10	16	24	15200	126
40	16	16	28.575(¹ / ₈)	19.4	0.7	9	15	24	20200	185
44	18	18	31.75(¹ / ₄)	21.9	0.7	9	15	24	25200	260
47	20	20	34.925(³ / ₈)	24.4	0.7	9	15	24	27800	340
51	22	22	38.1(¹ / ₂)	25.8	0.7	10	15	23	35900	435

[Clearance]

Unit: mm

Radial clearance	0.035 or less
Axial clearance	0.1 or less

[Initial Lubrication]

This model can be used without lubrication. However, if desiring to provide initial lubrication, apply oil or grease to the spherical area.

[Identification of Left-hand Thread]

If the male thread is left-hand, symbol "L" is added.

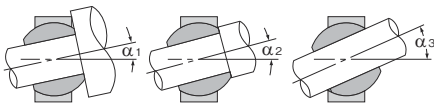

Permissible Tilt Angles

Model PB (Standard Type)

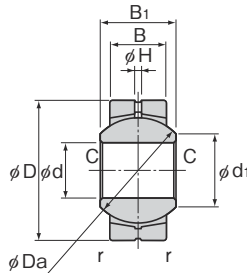

Unit: mm

Model No.	Main dimensions							Ball diameter Da mm (inch)	Permissible tilt angles			Static applied load Radial Cs N	Mass g
	Inner diameter d H7	Outer diameter D h6	Outer ring width B ±0.1	Inner ring width B ₁ 0 -0.1	d ₁	H	C, r		α ₁ °	α ₂ °	α ₃ °		
	PB 5	5	16	6	8	7.7	1		0.3	11.112(⁷ / ₁₆)	8		
PB 6	6	18	6.75	9	9	1	0.3	12.7(¹ / ₂)	8	13	30	9800	13
PB 8	8	22	9	12	10.4	1	0.5	15.875(⁵ / ₈)	8	14	25	16700	24
PB 10	10	26	10.5	14	12.9	1.2	0.5	19.05(³ / ₄)	8	14	25	23500	39
PB 12	12	30	12	16	15.4	1.5	0.5	22.225(⁷ / ₈)	8	13	25	31400	58
PB 14	14	34	13.5	19	16.9	1.5	0.7	25.4(1)	10	16	24	40200	84
PB 16	16	38	15	21	19.4	2.5	0.7	28.575(¹ / ₈)	9	15	24	50000	111
PB 18	18	42	16.5	23	21.9	2.5	0.7	31.75(¹ / ₄)	9	15	24	61800	160
PB 20	20	46	18	25	24.4	2.5	0.7	34.925(¹ / ₈)	9	15	24	73500	210
PB 22	22	50	20	28	25.8	2.5	0.7	38.1(¹ / ₂)	10	15	23	88200	265
PB 25	25	56	22	31	29.6	3	0.8	42.862(¹ / ₁₆)	9	15	23	111000	390
PB 30	30	66	25	37	34.8	3	0.8	50.8(2)	10	17	23	148000	610

[Material]

Outer ring : S35C
Spherical inner ring : SUJ2, 58 HRC or higher

(Hard chrome plated except for the inner surface of the inner ring)

Bush : copper alloy

[Clearance]

Unit: mm

Radial clearance	0.035 or less
Axial clearance	0.1 or less

[Fitting with the Shaft]

For the fitting between the shaft and the housing, the following values are recommended.

Condition		Shaft	Housing
Inner ring rotational load	Normal load	m6	H7
	Indeterminate load	n6	
Outer ring rotational load	Normal load	h7	M7
	Indeterminate load	k6	

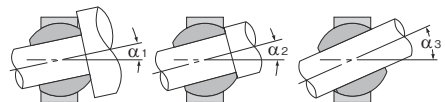

Permissible Tilt Angles

[Lubrication]

Apply lubricant before using the product.
The holder has a greasing hole and an oil groove; they allow grease to be replenished through the grease nipple as necessary.

Permissible Tilt Angles

The permissible tilting angles of Link Ball models are indicated in the corresponding specification tables.

Note) If the permissible tilt angle is exceeded, it may cause serious damage to the holder. Be sure to use the Link Ball within its permissible tilt angle.

Installation

Please note that the Rod End is not capable of receiving a thrust load indicated in Fig.1.

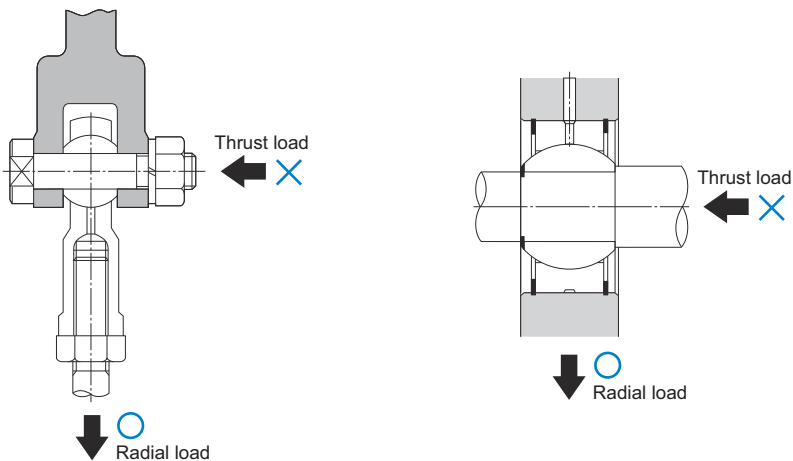

Fig.1 Examples of Installing the Rod End

Model Number Coding

Model number configurations differ depending on the model features. Refer to the corresponding sample model number configuration.

[Rod End]

- Models PHS, NHS-T, POS and NOS-T
-

PHS10 L

Model No.

Machine screw thread direction
No symbol: Right hand (standard)
L: Left hand

[Rod end (insert model)]

- Model PB
-

PB20

Model No.

Precautions on Use

Rod End

[Handling]

- (1) Do not disassemble the parts. This will result in loss of functionality.
- (2) Take care not to drop or strike the Rod End. Doing so may cause injury or damage. Giving an impact to it could also cause damage to its function even if the product looks intact.
- (3) When handling the product, wear protective gloves, safety shoes, etc., as necessary to ensure safety.

[Precautions on Use]

- (1) Do not use the product in the manner that the permissible tilting angle is exceeded since doing so may damage the product.
- (2) Prevent foreign material, such as cutting chips or coolant, from entering the product. Failure to do so may cause damage.
- (3) The Rod End is designed for use under a radial load. Do not use the product under a thrust load.
- (4) Do not use the product at temperature of 80°C or higher.
- (5) Insufficient rigidity or accuracy of mounting members causes the bearing load to concentrate on one point and the bearing performance will drop significantly. Accordingly, give sufficient consideration to the rigidity/accuracy of the housing and base and strength of the fixing bolts.

[Lubrication]

- (1) All Rod End models except lubrication-free models must be lubricated before use (THK recommends lithium grease no. 2). When lubricating the Rod End, do not combine different lubricants. Mixing lubricants can cause adverse interaction between disparate additives or other ingredients. While the unit is in use, replenish the lubricant whenever necessary.
- (2) When using the product in locations exposed to constant vibrations or in special environments such as clean rooms, vacuum and low/high temperature, use the grease appropriate for the specification/environment.

[Storage]

When storing the Rod End, enclose it in a package designated by THK and store it in a room while avoiding high temperature, low temperature and high humidity.

[Disposal]

Dispose of the product properly as industrial waste.



Rod End

THK General Catalog

B Support Book

Features and Types	B23-2
Features of the Rod End	B23-2
• Features	B23-2
Types of the Rod End	B23-3
• Types and Features	B23-3
Point of Selection	B23-5
Selecting a Rod End	B23-5
Installation	B23-6
Installation	B23-6
Model No.	B23-7
• Model Number Coding	B23-7
Precautions on Use	B23-8

A Product Descriptions (Separate)

Features and Types	A23-2
Features of the Rod End	A23-2
• Features	A23-2
Types of the Rod End	A23-3
• Types and Features	A23-3
Point of Selection	A23-5
Selecting a Rod End	A23-5
Dimensional Drawing, Dimensional Table	
Model PHS (Female Threading Type) ..	A23-6
Model NHS-T (No Lubrication Type) ..	A23-8
Model POS (Male Thread Type)	A23-10
Model NOS-T (No Lubrication, Male Thread Type) ..	A23-12
Model PB (Standard Type)	A23-14
Point of Design	A23-15
Permissible Tilt Angles	A23-15
Installation	A23-15
Model No.	A23-16
• Model Number Coding	A23-16
Precautions on Use	A23-17

Features of the Rod End

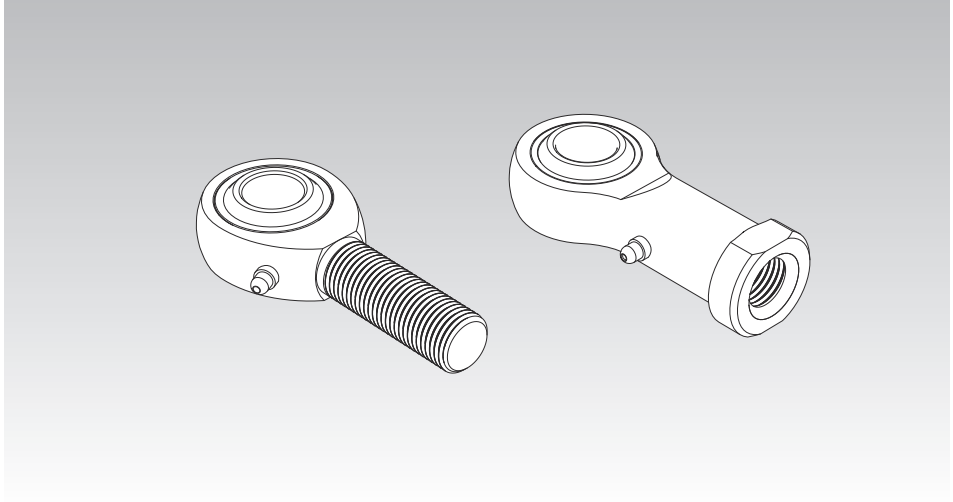

Features

The Rod End is a self-aligning plain bearing that uses a spherical inner ring which has the same level of accuracy and hardness as bearing steel balls. With the combination of a spherical inner ring whose sliding surface is mirror-finished and a rationally designed holder, the Rod End ensures play-free, extremely smooth rotation and oscillation.

Types of the Rod End

Types and Features

Type Provided with a Female Threading - Model PHS

Specification Table⇒ [A 23-6](#)

With model PHS, a copper alloy with high conformability is inserted between the chromate treated steel holder and the spherical inner ring, in which only the circumference of the spherical area is hard chrome plated. This structure ensures high rigidity, high wear resistance and high corrosion resistance.

The grease nipple on the holder allows grease to be applied to the sliding surface as necessary.

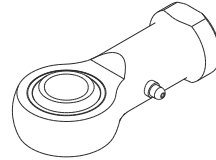

Model PHS

No Lubrication Type - Model NHS-T

Specification Table⇒ [A 23-8](#)

This no lubrication rod end uses self-lubricating synthetic resin formed between the steel holder and the spherical inner ring.

Since the clearance on the sliding surface is minimized, an accurate link motion is achieved.

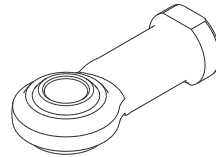

Model NHS-T

Male thread Type - Model POS

Specification Table⇒ [A 23-10](#)

This model is a highly rigid rod end that is basically the same as the female threading type model PHS, but has a male thread on the holder end.

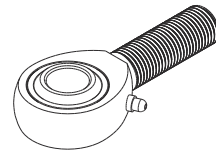

Model POS

No Lubrication, Male thread Type - Model NOS-T

Specification Table⇒ [A 23-12](#)

This model is a no lubrication rod end that is basically the same as the female threading type model NHS-T, but has a male thread on the holder end.

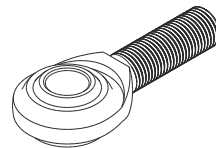

Model NOS-T

Standard Type - Model PB

With model PB, a copper alloy with high conformability is inserted between the steel outer ring and the spherical inner ring, in which only the spherical area is hard chrome plated. This structure makes this model a highly rigid Spherical Plain Bearing with high corrosion resistance and high wear resistance.

The oil groove and the greasing hole on the outer ring allow grease to be applied to the sliding surface as necessary.

Specification Table⇒ **A23-14**

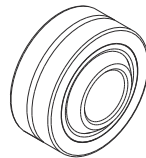

Model PB

Selecting a Rod End

[Permissible Load P]

The static load capacity (C_s) indicated in the specification tables, is presented as a guide for the mechanical strength of the Rod End. Select a bearing while taking into account the safety factor (f_s) indicated in Table1 according to the type of the load.

Table1 Safety Factor (f_s)

Type of load	Lower limit of f_s
Constant load in a constant direction	2 to 3
Fluctuating load in a constant direction	3 to 5
Load in varying directions	5 to 8

According to the type of load, select a bearing that satisfies the following equation from a mechanical strength's viewpoint.

$$P \leq \frac{C_s}{f_s} \quad \dots\dots(1)$$

- P : Permissible Load (N)
 C_s : Static load capacity (N)
 f_s : Safety factor (see Table1)

[Dynamic Load Capacity C_d]

The dynamic load capacity refers to the upper limit of load that the spherical area can receive without showing seizure while the Rod End is rotating or oscillating. The dynamic load capacity is obtained from the following approximation formula using the static load capacity (C_s) ^(note 1) indicated in the specification table.

$$C_d = \frac{C_s}{\sqrt[3]{n}} \quad \dots\dots(2)$$

- C_d : Dynamic load capacity (N)
 C_s : Static load capacity (N)
 n : Revolutions per minute (min^{-1})

The selected bearing must meet both the permissible load obtained from equation (1) and the dynamic load capacity obtained from equation (2).

Note1) Static load capacity (C_s) refers to the value obtained by multiplying the projected area on the spherical section by the permissible surface pressure, and is used to obtain the dynamic load capacity.

Installation

Please note that the Rod End is not capable of receiving a thrust load indicated in Fig.1.

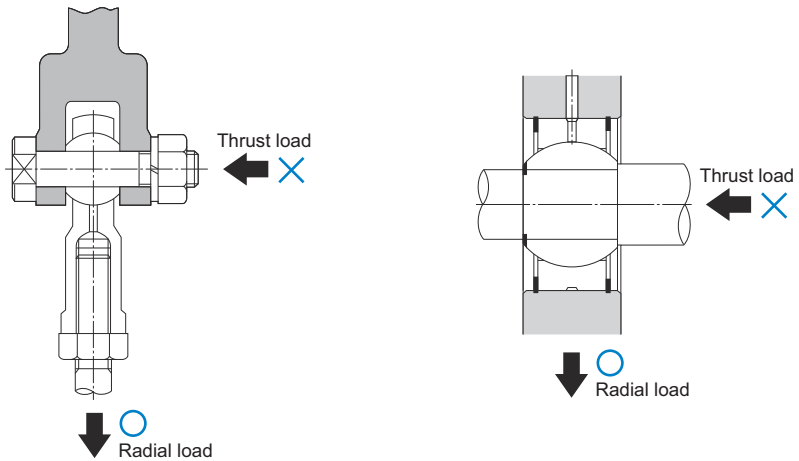

Fig.1 Examples of Installing the Rod End

Model Number Coding

Model number configurations differ depending on the model features. Refer to the corresponding sample model number configuration.

[Rod End]

- Models PHS, NHS-T, POS and NOS-T

PHS10 L

Model No.

Machine screw thread direction
No symbol: Right hand (standard)
L: Left hand

[Rod end (insert model)]

- Model PB

PB20

Model No.

Precautions on Use

Rod End

[Handling]

- (1) Do not disassemble the parts. This will result in loss of functionality.
- (2) Take care not to drop or strike the Rod End. Doing so may cause injury or damage. Giving an impact to it could also cause damage to its function even if the product looks intact.
- (3) When handling the product, wear protective gloves, safety shoes, etc., as necessary to ensure safety.

[Precautions on Use]

- (1) Do not use the product in the manner that the permissible tilting angle is exceeded since doing so may damage the product.
- (2) Prevent foreign material, such as cutting chips or coolant, from entering the product. Failure to do so may cause damage.
- (3) The Rod End is designed for use under a radial load. Do not use the product under a thrust load.
- (4) Do not use the product at temperature of 80°C or higher.
- (5) Insufficient rigidity or accuracy of mounting members causes the bearing load to concentrate on one point and the bearing performance will drop significantly. Accordingly, give sufficient consideration to the rigidity/accuracy of the housing and base and strength of the fixing bolts.

[Lubrication]

- (1) All Rod End models except lubrication-free models must be lubricated before use (THK recommends lithium grease no. 2). When lubricating the Rod End, do not combine different lubricants. Mixing lubricants can cause adverse interaction between disparate additives or other ingredients. While the unit is in use, replenish the lubricant whenever necessary.
- (2) When using the product in locations exposed to constant vibrations or in special environments such as clean rooms, vacuum and low/high temperature, use the grease appropriate for the specification/environment.

[Storage]

When storing the Rod End, enclose it in a package designated by THK and store it in a room while avoiding high temperature, low temperature and high humidity.

[Disposal]

Dispose of the product properly as industrial waste.