



Link Ball®

THK General Catalog

A Product Descriptions

Features and Types	A22-2
Features of the Link Ball	A22-2
• Structure and Features	A22-2
• Alloy	A22-5
• How Load Directions Are Called	A22-7
• Pushing Load and Pulling Load	A22-7
Types of the Link Ball	A22-8
• Types and Features	A22-8
Point of Selection	A22-10
Selecting a Link Ball	A22-10
Dimensional Drawing, Dimensional Table	
Model BL and Model BL-A	A22-12
Model RBI	A22-14
Point of Design	A22-16
Permissible Tilt Angles	A22-16
Example of Installation	A22-16
Model No.	A22-17
• Model Number Coding	A22-17
Precautions on Use	A22-18

B Support Book (Separate)

Features and Types	B22-2
Features of the Link Ball	B22-2
• Structure and Features	B22-2
• Alloy	B22-5
• How Load Directions Are Called	B22-7
• Pushing Load and Pulling Load	B22-7
Performance Tests with the Link Ball ..	B22-8
• Durability Tests with Link Ball Model BL ..	B22-8
Types of the Link Ball	B22-10
• Types and Features	B22-10
Installation	B22-12
Example of Installation	B22-12
Model No.	B22-13
• Model Number Coding	B22-13
Precautions on Use	B22-14

Features of the Link Ball

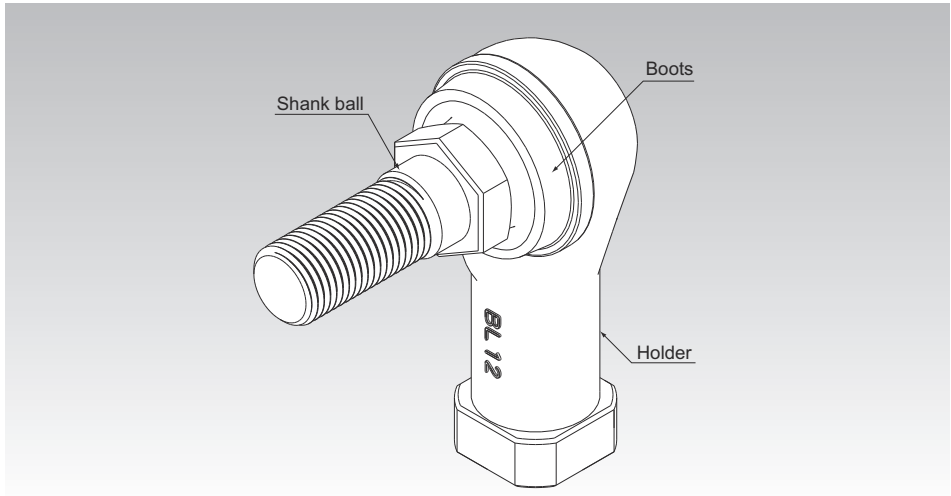

Fig.1 Structure of Link Ball Model BL

Structure and Features

With the Link Ball, a highly accurate bearing steel ball used in the spherical area is first encased in the holder by die cast molding, and then is specially welded with the shank. This unique process enables the mirror surface of the steel ball to be transferred or duplicated on the spherical surface inside the holder to ensure full contact between the ball and the holder. As a result, smooth motion is achieved with a minimum clearance.

Features and Types

Features of the Link Ball

[Compact Design]

Model BL has an adequately firm and yet extremely compact shape because of a highly balanced design. This model is optimal for use in an automobile height sensor or transmission control.

[Achieves Sphericity of 0.001 mm]

The spherical surface of the shank ball is transferred on the inner surface of the holder while maintaining the sphericity of the bearing steel ball. This allows smooth motion to be achieved with a minimum clearance and provides favorable operability and feel to the link motion.



Sphericity: 0.001 mm

Sphericity of the spherical surface of the ball shank

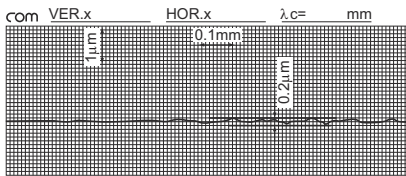

Roughness of the spherical surface of the ball shank

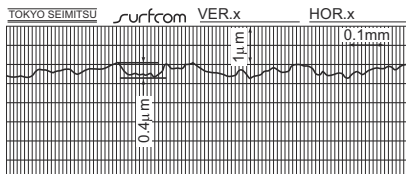

Roughness of the spherical surface of the holder

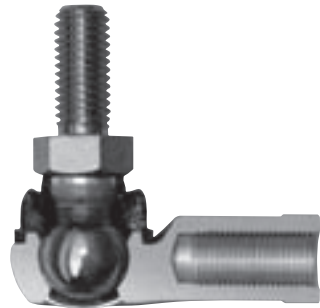

Cut sample of the spherical area of model BL

[Two Types of Holder Material]

Model BL-A uses the newly developed high strength aluminum alloy "A-1 Alloy" (see **A22-5**), which is light and highly resistant to wear.

Models BL6 and above and model RBI uses the proven high strength zinc alloy (see **A22-6**).

[High Lubricity]

The boot contains grease for high lubricity and increased wear resistance.

[Large Hexagonal Bolt Seat]

The hexagonal bolt seat of the shank has the same dimensions as the seating surface for small hexagon head bolts in accordance with automotive specifications. This prevents the seating surface from sinking and ensures a stable link motion mechanism.

[Equipped with a Boot for Protection against Muddy Water]

Use of a boot with high trackability in the ball shank prevents muddy water from entering the spherical area even in a muddy atmosphere. Accordingly, those types equipped with boots are used also in outdoor applications and automobile parts under the chassis. For details, see the muddy water test data (**B22-8** and **B22-9**).

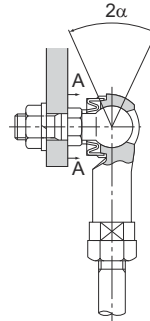

Model BL10



Model equivalent to similar product

A-A cross section

Jaw Span for Wrenching

Alloy

[High Strength Aluminum Alloy “A-1 Alloy”]

“A-1 Alloy,” a newly developed high strength aluminum alloy, is an alloy with Al-Zn-Si₃ being the main components, is used in the holder of model BL-A. Information on the mechanical properties, physical properties, and wear resistance of materials is presented below.

* The figures shown are target values—these figures are not guaranteed.

● Features of the A-1 Alloy

- Achieves one of the highest strengths among the existing aluminum die cast alloys.
- Has yield strength approximately twice that of the commonly used aluminum die cast alloy (ADC 12).
- Has hardness equal to the high strength zinc alloy and achieves high wear resistance.
- Achieves specific gravity less than a half of the high strength zinc alloy to allow significant weight saving.
- Highly corrosion resistance and can be used as an automotive part related to wheel control.

● Mechanical Properties

Tensile strength	: 343 to 392 N/mm ²
Tensile yield strength (0.2%)	: 245 to 294 N/mm ²
Compressive strength	: 490 to 637 N/mm ²
Compressive yield strength (0.2%)	: 294 to 343 N/mm ²
Charpy impact	: 0.098 to 0.196 N-m/mm ²
Elongation	: 2 to 3 %
Hardness	: 140 to 160 HV

● Physical Properties

Specific gravity	: 3
Melting point	: 570°C
Specific heat	: 793 J/(kg·k)
Linear expansion rate	: 22×10^{-6}

[High Strength Zinc Alloy]

The high strength zinc alloy used in the holders of models BL and RBI has been developed as a bearing alloy by mixing Al, Cu, Mg, Be and Ti as well as zinc as the base component. It is excellent in mechanical properties, seizure resistance and wear resistance. Information on mechanical properties, physical properties, and wear resistance is presented below.

* The figures shown are target values—these figures are not guaranteed.

● Mechanical Properties

Tensile strength	: 275 to 314 N/mm ²
Tensile yield strength (0.2%)	: 216 to 245 N/mm ²
Compressive strength	: 539 to 686 N/mm ²
Compressive yield strength (0.2%)	: 294 to 343 N/mm ²
Fatigue strength	: 132 N/mm ² × 10 ⁷ (Schenk bending test)
Charpy impact	: 0.098 to 0.49 N-m/mm ²
Elongation	: 1 to 5%
Hardness	: 120 to 145 HV

● Physical Properties

Specific gravity	: 6.8
Melting point	: 390°C
Specific heat	: 460 J/(kg·k)
Linear expansion rate	: 24 × 10 ⁻⁶

● Wear Resistance

The wear resistance of the high strength zinc alloy is superior to that of class-3 brass and class-3 bronze, almost equal to that of class-2 phosphor bronze.

Amsler wear-tester	
Test piece rotation speed	: 185 min ⁻¹
Load	: 392 N
Lubricant	: Dynamo oil

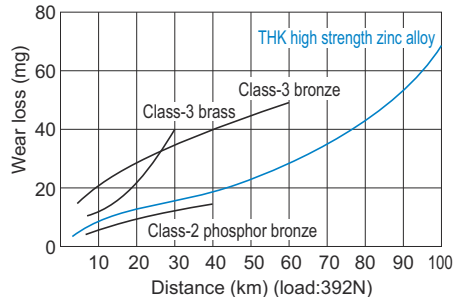

Fig.2 Wear Resistance of the High Strength Zinc Alloy

How Load Directions Are Called

Regardless of the shape, the direction of the load applied to the Link Ball is called “axial direction” if it is parallel to the axis of the ball shank, and “radial direction” if it is perpendicular to the axis.

Pushing Load and Pulling Load

Of the loads applied in the axial direction, the load in the direction of the ball shank being pressed toward the holder is called “pushing load” and the load in the direction of the ball shank being pulled from the holder is called “pulling load.”

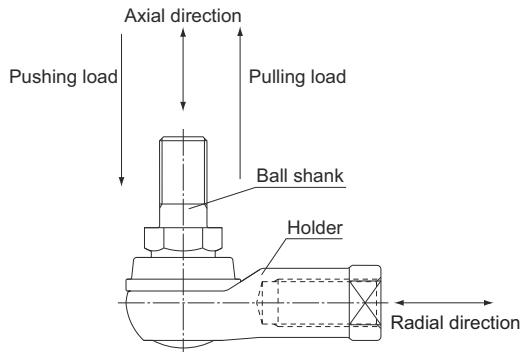

● Direction of applied load

The following table shows the load application direction of each model. Avoid using the product in a different load application direction. Failure to do so may damage the product.

Model No.	Axial direction	Radial direction
Model BL	×	○
Model BL-A	×	○
Model RBI	○	×

Types of the Link Ball

Types and Features

Model BL

Specification Table⇒ [A22-12](#)

The holder made of high strength zinc alloy is connected perpendicularly to the shank incorporated with a ball.

With a grease pocket formed on the top and bottom of the spherical area, this model achieves high lubricity and high wear resistance.

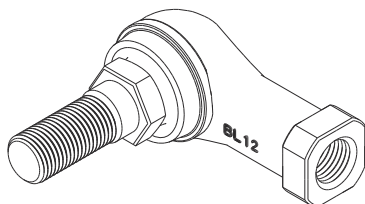

Model BL

Model BL-A (supported models: BL4A, BL5A only)

Specification Table⇒ [A22-12](#)

The holder is connected in perpendicular to the shank, which comprises a male thread specially welded with a highly accurate steel ball. With a grease pocket formed on the top and bottom of the spherical area, this model achieves high lubricity and high wear resistance.

Use of the A-1 alloy in the holder significantly reduces the weight.

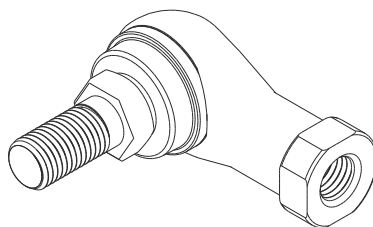

Model BL-A

A-1 Alloy, a high strength aluminum alloy newly developed for the Link Ball, has yield strength approximately twice that of the commonly used aluminum die cast material ADC 12, and its strength and wear resistance are equivalent to the high strength zinc alloy.

With its specific gravity less than that of the high strength zinc alloy, model BL-A is optimal as an automotive part that requires lightweight, high strength, high corrosion resistance and high wear resistance.

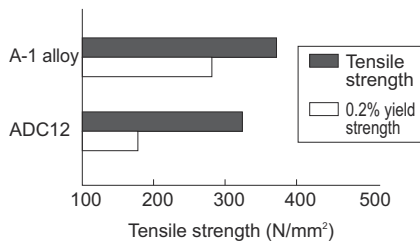

Fig.3 Tensile Strength and Yield Strength of THK A-1 Alloy and ADC 12

Features and Types

Types of the Link Ball

Model RBI

With this Link Ball model, the high strength zinc alloy is used in its holder, and the mounting bolt and the holder are arranged on the same axis, allowing this model to receive an axial load.

Since grease is contained in the boot, this model achieves high lubricity and high wear resistance.

Specification Table⇒ **A22-14**

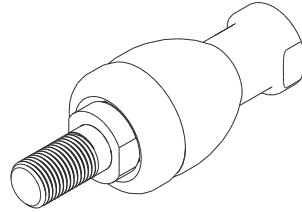

Model RBI

Selecting a Link Ball

The selected bearing must meet both the permissible load obtained from equation (1) and the dynamic load capacity obtained from equation (2).

[Permissible Load P]

The yield-point strength indicated in the specification tables refers to the mechanical strength of the bearing. For model BL, the yield-point strength indicates the strength when a load is applied to the ball shank in a radial direction. For model RBI, it indicates the strength when a load is applied to the ball shank in an axial direction with respect to the holder. (For the load direction, see **A22-7**.)

Table1 Safety Factor (f_s)

Type of load	Lower limit of f_s
Constant load in a constant direction	2 to 3
Fluctuating load in a constant direction	3 to 5
Load in varying directions	5 to 8

According to the type of the load, select a bearing that satisfies the following equation from a mechanical strength's viewpoint.

$$P \leq \frac{P_k}{f_s} \quad \dots\dots\dots(1)$$

P : Permissible Load (N)
 P_k : Yield-point strength (N)
 f_s : Safety factor (see Table1)

[Dynamic Load Capacity C_d]

The dynamic load capacity (C_d) refers to the upper limit of load that the spherical area of the Link Ball can receive without showing seizure while the Link Ball is rotating or oscillating. The dynamic load capacity is obtained from the following approximation formula using the static load capacity (C_s) (note) indicated in the dimensional table.

$$C_d = \frac{C_s}{\sqrt[3]{n}} \quad \dots\dots\dots(2)$$

C_d : Dynamic load capacity (N)
 C_s : Static load capacity (N)
 n : Revolutions per minute (min⁻¹)

Note) Static load capacity (C_s) refers to the value obtained by multiplying the projected area on the spherical section by the permissible surface pressure, and is used to obtain the dynamic load capacity.

Point of Selection

Selecting a Link Ball

Link Ball

Model BL and Model BL-A

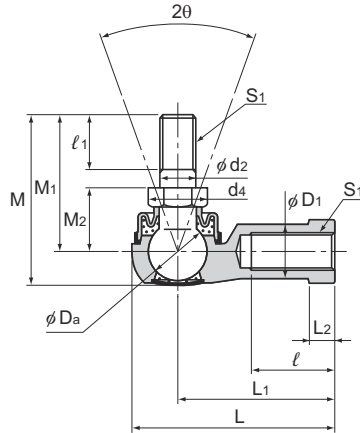

Model No.	Outer dimensions			Threaded S ₁ JIS Class 2	Holder dimensions					
	Length L	Diameter D	Height M		L ₁	ℓ	L ₂	D ₁	D ₂	W 0 -0.3
BL 4DA	24.5	13	20	M4×0.7	18	8	4	7.5	9.5	8
BL 5DA	34.5	15	26.7	M5×0.8	27	15	4	9	12	10
BL 6D	38	16	32.6	M6×1	30	16	5	10	13	11
BL 8D	45.5	19	38.6	M8×1.25	36	19	6	12.5	16	14
BL 10D	55.5	25	46.3	M10×1.25	43	23	7	14.5	19	17
BL 10BD	55.5	25	52.3	M10×1.5	43	23	7	14.5	19	17
BL 12D	64.5	29	52.7	M12×1.25	50	26	8	17.5	22	19
BL 12BD	64.5	29	59.7	M12×1.75	50	26	8	17.5	22	19
BL 14D	74	34	68.4	M14×1.5	57	30	10	20	25	22
BL 14BD	74	34	74.4	M14×2	57	30	10	20	25	22
BL 16D	83	38	74	M16×1.5	64	34	11	22	27	24
BL 16BD	83	38	80	M16×2	64	34	11	22	27	24

Note) Model BL-A is only available in size 4 and 5.

[Material]

Holder : A-1 alloy (BL4 to 5) (see **A22-5**)
 : High strength zinc alloy (BL6 to 16) (see **A22-6**)
 Ball shank : Lightly Carburized Carbon Steel Ball:
 650 HV or higher
 Shank S35C (20 to 28 HRC)
 Chromate treatment
 Boot : NBR special synthetic rubber

[Spherical Clearance]

Radial direction : 0.02 to 0.06mm
 Axial direction : 0.3mm or less

[Tolerance of the Mating Hole of the Ball Shank]

H10 is recommended

Model number coding

BL6 D L

Model number | D | L
 With boot attached | | Screw symbol

Screw symbol	No symbol	L
Holder unit set screw	Right-hand	Left-hand
Ball shank	Right-hand	

Note) No model is available without boot.

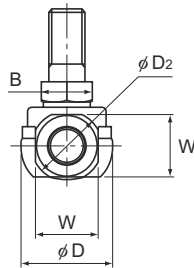

Unit: mm

Ball shank dimensions							Ball diameter Da	Permissible tilt angles 20°	Applied static load C _s N	Yield-point strength P _k N	Mass g
d ₂ h9	M ₁	M ₂ ±0.3	ℓ ₁	Hexagon B 0 -0.3	d ₄						
4	15	7	6	7	8.1	7.938	40	4510	1370	7	
5	21	10	8	8	9.2	9.525	40	6470	2250	12	
6	26	11	11	10	11.6	11.112	40	9900	3920	26	
8	31	14	12	12	13.8	12.7	40	12500	6570	49	
10	37	17	15	14	16.2	15.875	40	18300	11300	87	
10	43	17	21	14	16.2	15.875	40	18300	11300	90	
12	42	19	17	17	19.6	19.05	40	26700	16400	143	
12	49	19	24	17	19.6	19.05	40	26700	16400	148	
14	56	21.5	22	19	21.9	22.225	40	36400	19800	235	
14	62	21.5	28	19	21.9	22.225	40	36400	19800	245	
16	60	23.5	23	22	25.4	22.225	30	36400	26900	315	
16	66	23.5	29	22	25.4	22.225	30	36400	26900	325	

[Yield-Point Strength]

It indicates the strength in the direction shown in the figure below.

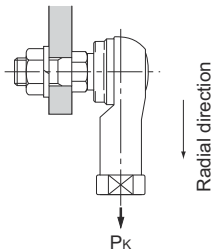
**[Lubrication]**

Lithium soap group grease No. 2 is contained in the boot and the cap.

[Identification of Left-hand Thread]

If the female threading is left-handed, its identification depends on the marking.

Threaded	Identification
	Cap marking
Right-hand	—
Left-hand	L mark

Model RBI

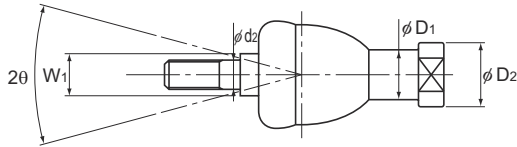

Model No.	Outer dimensions		Threaded S ₁ JIS Class 2	Holder dimensions						Shaft diameter
	Length L	Diameter D		L ₁	L ₂	ℓ	D ₁	D ₂	W 0 -0.3	d ₂ h9
RBI 5D	46	17	M5×0.8	24	4	12	9	11	9	5
RBI 6D	55.2	20	M6×1	28	5	15	10	13	11	6
RBI 8D	65	24	M8×1.25	32	5	16	12.5	16	14	8
RBI 10D	74.5	28	M10×1.25	35	6.5	18	15	19	17	10
RBI 10BD	80.5	28	M10×1.5	35	6.5	18	15	19	17	10
RBI 12D	84	32	M12×1.25	40	6.5	20	17.5	22	19	12
RBI 12BD	91	32	M12×1.75	40	6.5	20	17.5	22	19	12
RBI 14D	103	36	M14×1.5	45	8	25	20	25	22	14
RBI 14BD	109	36	M14×2	45	8	25	20	25	22	14
RBI 16D	112	40	M16×1.5	50	8	27	22	27	22	16
RBI 16BD	118	40	M16×2	50	8	27	22	27	22	16

[Material]

Holder : High strength zinc alloy (see **A22-6**)
 Ball shank : Bearing steel ball Hardness: 650 HV or higher
 Shank S35C
 Chromate treatment
 Boot : NBR special synthetic rubber

[Spherical Clearance]

Radial direction : 0.03mm or less
 Axial direction : 0.1mm or less

[Tolerance of the Mating Hole of the Ball Shank]

H10 is recommended.

Model number coding

RBI10 D L

Model number

With boot attached

Screw symbol

Screw symbol	No symbol	L
Holder unit set screw	Right-hand	Left-hand
Ball shank	Right-hand	

Note) No model is available without boot.

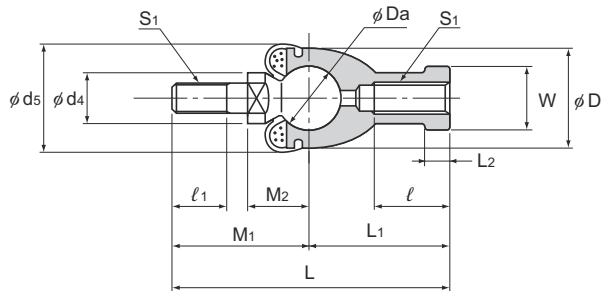

Unit: mm

Ball shank dimensions					Boot d ₅	Ball diameter D _a	Permissible tilt angles 2θ°	Applied static load		Yield-point strength P _k N	Mass g
M ₁	M ₂ ±0.3	ℓ ₁	W ₁ 0 -0.3	d ₄				Tensile C _s N	Compressive C _s N		
22	11	8	7	9	20	11.112	25	5690	11400	2840	25
27.2	12.2	11	8	10	20	12.7	25	7450	14900	3730	40
33	16	12	10	12	24	15.875	25	11700	23200	5880	75
39.5	19.5	15	11	14	30	19.05	25	16800	33500	8430	120
45.5	19.5	21	11	14	30	19.05	25	16800	33500	8430	123
44	21	17	17	19	32	22.225	25	22800	45600	11400	185
51	21	24	17	19	32	22.225	25	22800	45600	11400	190
58	23.5	22	17	19	38	25.4	17	29800	59600	14900	275
64	23.5	28	17	19	38	25.4	17	29800	59600	14900	280
62	25.5	23	19	22	44	25.4	17	29800	59600	14900	360
68	25.5	29	19	22	44	25.4	17	29800	59600	14900	370

[Yield-Point Strength]

It indicates the strength in the direction shown in the figure below.

Axial direction
→

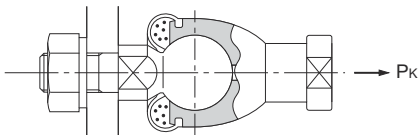
**[Lubrication]**

Lithium soap group grease No. 2 is contained in the boot.

[Identification of Left-hand Thread]

If the female threading is left-hand, symbol "L" is added.
The actual product is marked with symbol "L" on the holder.

Permissible Tilt Angles

The permissible tilting angles of Link Ball models are indicated in the corresponding specification tables.

Note) If the permissible tilt angle is exceeded, it may cause serious damage to the holder or the boot. Be sure to use the Link Ball within its permissible tilt angle.

Example of Installation

[Comparison of THK Link Ball and the Conventional Rod End]

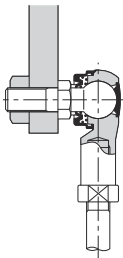

THK model BL

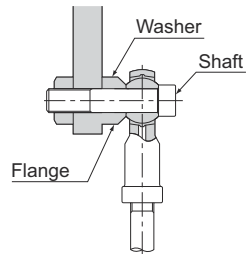

Conventional Rod End model PHS

- Since it has a shaft, model BL can easily be installed (especially useful for rod assembly).
- Because of the improved shape of the boot lip, the spherical area is protected from muddy water even in a muddy atmosphere.
- Since it contains grease, it can be used without further lubrication.
- Unlike the conventional type, which has a clearance between the shaft and the inner circumference of the inner ring and cannot be fixed completely, model BL has minimum distortion and high rigidity since the shank is integrated with the ball.

[Examples of Installing Model RBI]

Joint for cylinder end metal fitting

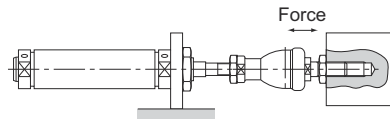

Suspending a light object

Connecting a rod in the axial direction

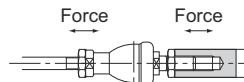

Rotation support

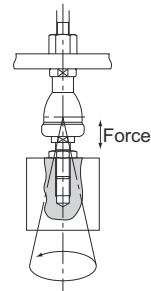
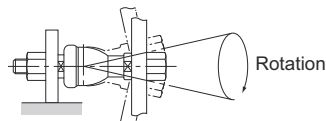

Model Number Coding

Model number configurations differ depending on the model features. Refer to the corresponding sample model number configuration.

[Link Ball]

● Models BL and RBI

BL12 D L

Model No. | | |
 With boot attached | | |

Machine screw thread direction
 No symbol: Right hand (standard)
 L: Left hand

Note) No model is available without boot.

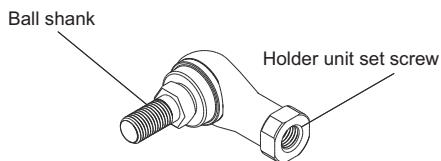

Screw symbols	No symbol	L
Holder unit set screw	Right-hand	Left-hand
Ball shank	Right-hand	

Precautions on Use

Link Ball

[Service Temperature]

The service temperature of the Link Ball series is basically between -20°C and 80°C . If the service temperature exceeds this range, contact THK. (See examples of testing the product at temperature other than the above service temperature range on [B22-8](#) to [B22-9](#).)

[Handling]

- (1) Do not disassemble the parts. This will result in loss of functionality.
- (2) Take care not to drop or strike the Link Ball. Doing so may cause injury or damage. Giving an impact to it could also cause damage to its function even if the product looks intact.
- (3) When handling the product, wear protective gloves, safety shoes, etc., as necessary to ensure safety.

[Precautions on Use]

- (1) Do not use the product in the manner that the permissible tilting angle is exceeded since doing so may damage the product.
- (2) Prevent foreign material, such as cutting chips or coolant, from entering the product. Failure to do so may cause damage.
- (3) Model BL is designed for use under loading in radial direction, while model RBI is designed for use under loading in axial direction.
- (4) Insufficient rigidity or accuracy of mounting members causes the bearing load to concentrate on one point and the bearing performance will drop significantly. Accordingly, give sufficient consideration to the rigidity/accuracy of the housing and base and strength of the fixing bolts.

[Lubrication]

- (1) Lithium soap group grease No. 2 is contained in all boots and can be used without further greasing.
- (2) Do not mix different lubricants. Mixing greases using the same type of thickening agent may still cause adverse interaction between the two greases if they use different additives, etc.
- (3) When using the product in locations exposed to constant vibrations or in special environments such as clean rooms, vacuum and low/high temperature, use the grease appropriate for the specification/environment.

[Storage]

When storing the Link Ball, enclose it in a package designated by THK and store it in a room while avoiding high temperature, low temperature and high humidity.

[Disposal]

Dispose of the product properly as industrial waste.



Link Ball®

THK General Catalog

B Support Book

Features and Types	B22-2
Features of the Link Ball	B22-2
• Structure and Features	B22-2
• Alloy	B22-5
• How Load Directions Are Called	B22-7
• Pushing Load and Pulling Load	B22-7
Performance Tests with the Link Ball ..	B22-8
• Durability Tests with Link Ball Model BL ..	B22-8
Types of the Link Ball	B22-10
• Types and Features	B22-10
Installation	B22-12
Example of Installation	B22-12
Model No.	B22-13
• Model Number Coding	B22-13
Precautions on Use	B22-14

A Product Descriptions (Separate)

Features and Types	A22-2
Features of the Link Ball	A22-2
• Structure and Features	A22-2
• Alloy	A22-5
• How Load Directions Are Called	A22-7
• Pushing Load and Pulling Load	A22-7
Types of the Link Ball	A22-8
• Types and Features	A22-8
Point of Selection	A22-10
Selecting a Link Ball	A22-10
Dimensional Drawing, Dimensional Table	
Model BL and Model BL-A	A22-12
Model RBI	A22-14
Point of Design	A22-16
Permissible Tilt Angles	A22-16
Example of Installation	A22-16
Model No.	A22-17
• Model Number Coding	A22-17
Precautions on Use	A22-18

Features of the Link Ball

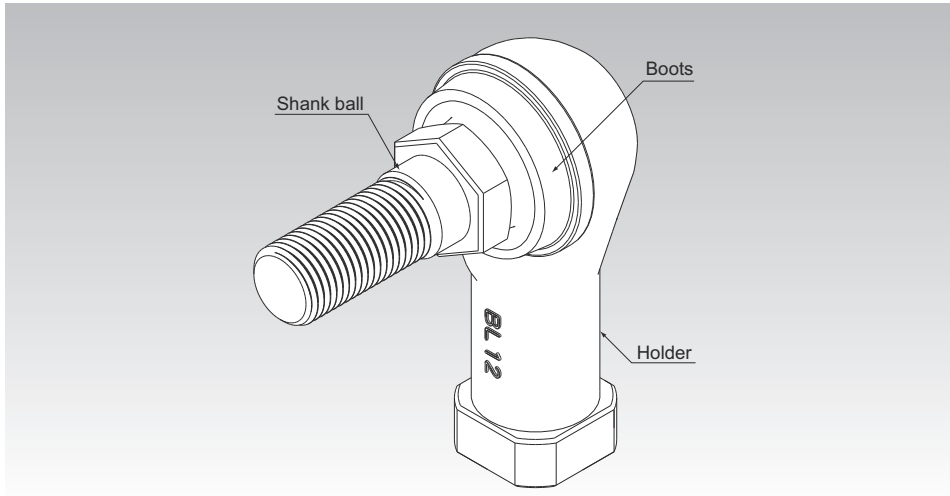

Fig.1 Structure of Link Ball Model BL

Structure and Features

With the Link Ball, a highly accurate bearing steel ball used in the spherical area is first encased in the holder by die cast molding, and then is specially welded with the shank. This unique process enables the mirror surface of the steel ball to be transferred or duplicated on the spherical surface inside the holder to ensure full contact between the ball and the holder. As a result, smooth motion is achieved with a minimum clearance.

Features and Types

Features of the Link Ball

[Compact Design]

Model BL has an adequately firm and yet extremely compact shape because of a highly balanced design. This model is optimal for use in an automobile height sensor or transmission control.

[Achieves Sphericity of 0.001 mm]

The spherical surface of the shank ball is transferred on the inner surface of the holder while maintaining the sphericity of the bearing steel ball. This allows smooth motion to be achieved with a minimum clearance and provides favorable operability and feel to the link motion.



Sphericity: 0.001 mm

Sphericity of the spherical surface of the ball shank

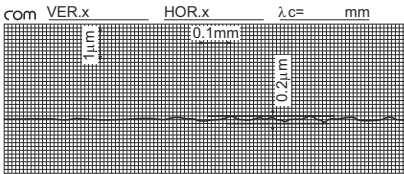

Roughness of the spherical surface of the ball shank

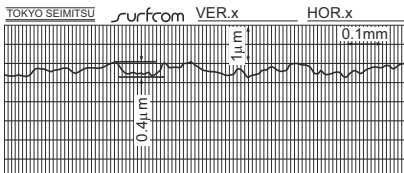

Roughness of the spherical surface of the holder

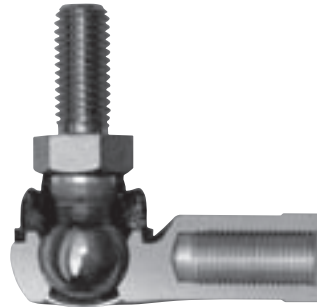
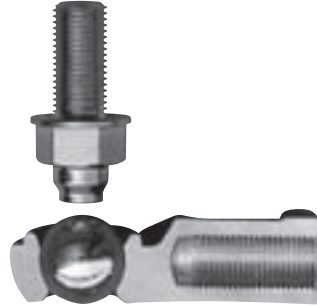

Cut sample of the spherical area of model BL

[Two Types of Holder Material]

Model BL-A uses the newly developed high strength aluminum alloy "A-1 Alloy" (see [B 22-5](#)), which is light and highly resistant to wear.

Models BL6 and above and model RBI uses the proven high strength zinc alloy (see [B 22-6](#)).

[High Lubricity]

The boot contains grease for high lubricity and increased wear resistance.

[Large Hexagonal Bolt Seat]

The hexagonal bolt seat of the shank has the same dimensions as the seating surface for small hexagon head bolts in accordance with automotive specifications. This prevents the seating surface from sinking and ensures a stable link motion mechanism.

[Equipped with a Boot for Protection against Muddy Water]

Use of a boot with high trackability in the ball shank prevents muddy water from entering the spherical area even in a muddy atmosphere. Accordingly, those types equipped with boots are used also in outdoor applications and automobile parts under the chassis. For details, see the muddy water test data ([B 22-8](#) and [B 22-9](#)).

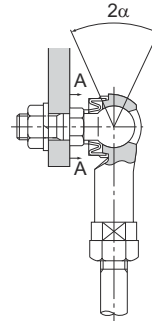

Model BL10



Model equivalent to similar product

A-A cross section

Jaw Span for Wrenching

Alloy

[High Strength Aluminum Alloy “A-1 Alloy”]

“A-1 Alloy,” a newly developed high strength aluminum alloy, is an alloy with Al-Zn-Si₃ being the main components, is used in the holder of model BL-A. Information on the mechanical properties, physical properties, and wear resistance of materials is presented below.

* The figures shown are target values—these figures are not guaranteed.

● Features of the A-1 Alloy

- Achieves one of the highest strengths among the existing aluminum die cast alloys.
- Has yield strength approximately twice that of the commonly used aluminum die cast alloy (ADC 12).
- Has hardness equal to the high strength zinc alloy and achieves high wear resistance.
- Achieves specific gravity less than a half of the high strength zinc alloy to allow significant weight saving.
- Highly corrosion resistance and can be used as an automotive part related to wheel control.

● Mechanical Properties

Tensile strength	: 343 to 392 N/mm ²
Tensile yield strength (0.2%)	: 245 to 294 N/mm ²
Compressive strength	: 490 to 637 N/mm ²
Compressive yield strength (0.2%)	: 294 to 343 N/mm ²
Charpy impact	: 0.098 to 0.196 N-m/mm ²
Elongation	: 2 to 3 %
Hardness	: 140 to 160 HV

● Physical Properties

Specific gravity	: 3
Melting point	: 570°C
Specific heat	: 793 J/(kg·k)
Linear expansion rate	: 22×10^{-6}

[High Strength Zinc Alloy]

The high strength zinc alloy used in the holders of models BL and RBI has been developed as a bearing alloy by mixing Al, Cu, Mg, Be and Ti as well as zinc as the base component. It is excellent in mechanical properties, seizure resistance and wear resistance. Information on mechanical properties, physical properties, and wear resistance is presented below.

* The figures shown are target values—these figures are not guaranteed.

● Mechanical Properties

Tensile strength	: 275 to 314 N/mm ²
Tensile yield strength (0.2%)	: 216 to 245 N/mm ²
Compressive strength	: 539 to 686 N/mm ²
Compressive yield strength (0.2%)	: 294 to 343 N/mm ²
Fatigue strength	: 132 N/mm ² × 10 ⁷ (Schenk bending test)
Charpy impact	: 0.098 to 0.49 N-m/mm ²
Elongation	: 1 to 5%
Hardness	: 120 to 145 HV

● Physical Properties

Specific gravity	: 6.8
Melting point	: 390°C
Specific heat	: 460 J/(kg·k)
Linear expansion rate	: 24 × 10 ⁻⁶

● Wear Resistance

The wear resistance of the high strength zinc alloy is superior to that of class-3 brass and class-3 bronze, almost equal to that of class-2 phosphor bronze.

Amsler wear-tester	
Test piece rotation speed	: 185 min ⁻¹
Load	: 392 N
Lubricant	: Dynamo oil

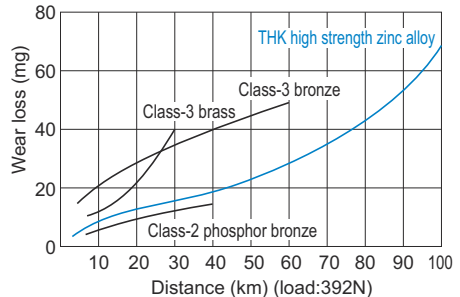

Fig.2 Wear Resistance of the High Strength Zinc Alloy

How Load Directions Are Called

Regardless of the shape, the direction of the load applied to the Link Ball is called “axial direction” if it is parallel to the axis of the ball shank, and “radial direction” if it is perpendicular to the axis.

Pushing Load and Pulling Load

Of the loads applied in the axial direction, the load in the direction of the ball shank being pressed toward the holder is called “pushing load” and the load in the direction of the ball shank being pulled from the holder is called “pulling load.”

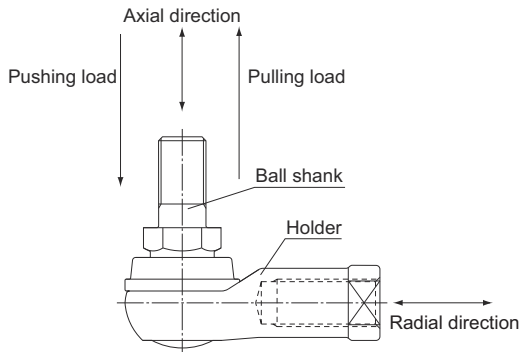

● Direction of applied load

The following table shows the load application direction of each model. Avoid using the product in a different load application direction. Failure to do so may damage the product.

Model No.	Axial direction	Radial direction
Model BL	×	○
Model BL-A	×	○
Model RBI	○	×

Performance Tests with the Link Ball

Durability Tests with Link Ball Model BL

[Purpose of the Tests]

The tests were conducted to identify the performance difference between THK Link Ball model BL and an equivalent product of a competitor. As a result, model BL has been used in joints for transmission control units of automobiles, trucks and buses and for steering mechanisms of agricultural tractors.

[Tested Product, Test Items, Test Conditions and Test Results]

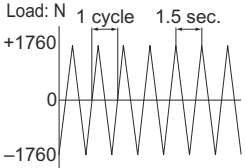
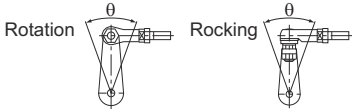
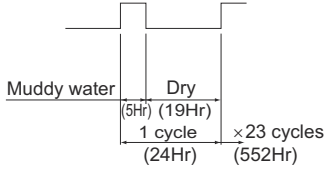
Test item	Tested model No.	Test conditions					Load conditions, etc.
		Applied load	Rotation or rocking angle	Frequency	Total number of revolutions or time	Service environment	
Rotation and-rocking durability	Comparison of THK Link Ball model BL10D and competitor's product	$\pm 1760\text{N}$ (Radial direction)	Rotation angle: $\theta = \pm 20^\circ$ Rocking angle: $\alpha = \pm 20^\circ$	40 times/min.	1,000,000 cycles	Normal temperature	<p>The loading diagram is as follows.</p>  <p>The motion direction is as follows:</p> 
Low-temperature rotation durability	THK Link Ball model BL10D only	$\pm 1225\text{N}$ (Radial direction)	Rotation angle: $\theta = \pm 30^\circ$	60 times/min.		-30°C	Low-temperature retention time: 280 hours Motion in the rotational direction
High-temperature rotation durability						100°C	High temperature retention time: 280 hours Motion in the rotational direction
Muddy-water rotation durability						Normal temperature	<p>Motion: rotational direction and oscillation on a separate basis Muddy water discharge pattern Muddy water concentration: 5 Wt% of salt and dust each in 1 liter of water Discharge direction: against the boot lip Discharge pressure: 5 kg/cm²</p> 
Muddy-water rocking durability	Comparison of THK Link Ball model BL10D and competitor's product	Rocking angle: $\alpha = \pm 20^\circ$					

Features and Types

Performance Tests with the Link Ball

[Comprehensive Evaluation]

As a result of comparing THK Link Ball model BL10D and a competitor's product in representative durability tests, it is demonstrated that model BL10D is superior in strength and wear resistance of the holder and sealability of the boot.

These features are achieved through THK's unique manufacturing process for the holder and the shank, the material used, the structure of upper and lower grease pockets on the spherical area and the development of a highly sealable boot.

	Test Result				Evaluation		
	Sample No.	Change in clearance (μm)		Conditions of the holder, etc.			
		Radial direction	Axial direction				
THK model BL10D	(1)	26	42	The shank was capable of smoothly rotating after the 1-million cycle test, and capable of continuously operating.	<ul style="list-style-type: none"> Even in complex link motion, THK model BL10D demonstrated higher durability and wear resistance of the holder than competitor's product. 		
	(2)	25	40				
Competitor's product	(1)	Broke in the holder neck after 8,600 cycles 154	60	Wear and damage were observed in the holder's spherical area in approx. 150,000-cycle operation.	<ul style="list-style-type: none"> The abrasion loss of the competitor's product immediately before the breakage of the holder was 6 times greater than THK model BL10D (Radial direction). 		
	(2)	Broke in the holder neck after 151,300 cycles 62	20				
	(1)	63	65	The boot did not show a crack or the like at low temperature	<ul style="list-style-type: none"> This indicates that THK model BL10D is sufficiently capable of operating in outdoor applications in cold climates. 		
	(2)	56	59				
THK model BL10D	(1)	79	84	The holder did not show abnormal wear and the boot did not show thermal deterioration at high temperature.	<ul style="list-style-type: none"> This indicates that THK model BL10D is sufficiently capable of operating in hot areas of a truck engine. 		
	(2)	74	78				
	(1)	48	51			No muddy-water penetration that may cause wear was observed.	<ul style="list-style-type: none"> This indicates that THK model BL10D is sufficiently capable of operating in environments subject to muddy water such as trucks, construction vehicles and agricultural machines since the sealing effect of the boot prevents penetration of muddy water.
	(2)	57	63				
(1)	32	38					
(2)	35	42					
Competitor's product	(1)	240	105	Muddy water penetrated the boot, the spherical area showed chipping and the boot had cuts.	<ul style="list-style-type: none"> The competitor's product cannot be used in environments subject to muddy water since chipping or the like may occur in such environments. In addition, wear of the spherical area reached 0.24 mm, 7.4 times greater than THK model BL10D. 		
	(2)	246	107				

Types of the Link Ball

Types and Features

Model BL

Specification Table⇒ [A22-12](#)

The holder made of high strength zinc alloy is connected perpendicularly to the shank incorporated with a ball.

With a grease pocket formed on the top and bottom of the spherical area, this model achieves high lubricity and high wear resistance.

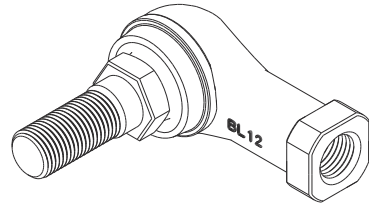

Model BL

Model BL-A (supported models: BL4A, BL5A only)

Specification Table⇒ [A22-12](#)

The holder is connected in perpendicular to the shank, which comprises a male thread specially welded with a highly accurate steel ball. With a grease pocket formed on the top and bottom of the spherical area, this model achieves high lubricity and high wear resistance.

Use of the A-1 alloy in the holder significantly reduces the weight.

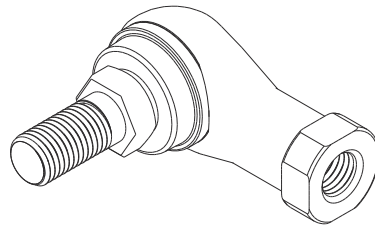

Model BL-A

A-1 Alloy, a high strength aluminum alloy newly developed for the Link Ball, has yield strength approximately twice that of the commonly used aluminum die cast material ADC 12, and its strength and wear resistance are equivalent to the high strength zinc alloy.

With its specific gravity less than that of the high strength zinc alloy, model BL-A is optimal as an automotive part that requires lightweight, high strength, high corrosion resistance and high wear resistance.

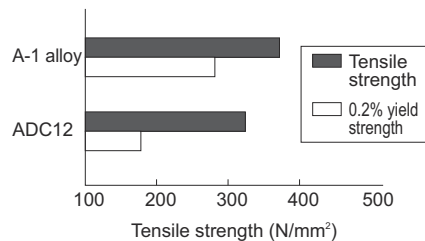

Fig.3 Tensile Strength and Yield Strength of THK A-1 Alloy and ADC 12

Features and Types

Types of the Link Ball

Model RBI

With this Link Ball model, the high strength zinc alloy is used in its holder, and the mounting bolt and the holder are arranged on the same axis, allowing this model to receive an axial load.

Since grease is contained in the boot, this model achieves high lubricity and high wear resistance.

Specification Table⇒ **A**22-14

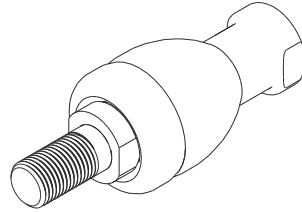

Model RBI

Example of Installation

[Comparison of THK Link Ball and the Conventional Rod End]

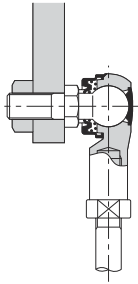

THK model BL

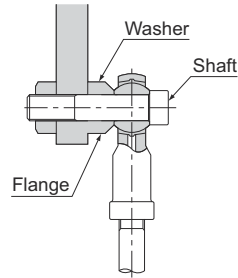

Conventional Rod End model PHS

- Since it has a shaft, model BL can easily be installed (especially useful for rod assembly).
- Because of the improved shape of the boot lip, the spherical area is protected from muddy water even in a muddy atmosphere.
- Since it contains grease, it can be used without further lubrication.
- Unlike the conventional type, which has a clearance between the shaft and the inner circumference of the inner ring and cannot be fixed completely, model BL has minimum distortion and high rigidity since the shank is integrated with the ball.

[Examples of Installing Model RB1]

Joint for cylinder end metal fitting

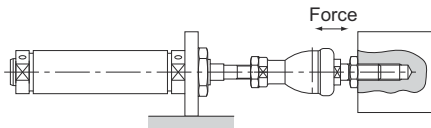

Suspending a light object

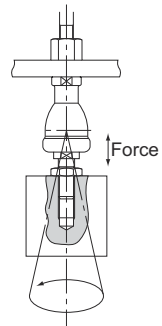

Connecting a rod in the axial direction

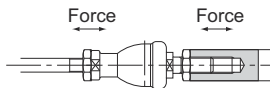

Rotation support

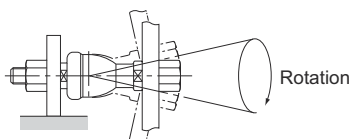

Model Number Coding

Model number configurations differ depending on the model features. Refer to the corresponding sample model number configuration.

[Link Ball]

● Models BL and RBI

BL12 D L

Model No. | | |
 With boot attached | | |

Machine screw thread direction
 No symbol: Right hand (standard)
 L: Left hand

Note) No model is available without boot.

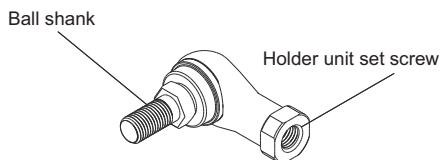

Screw symbols	No symbol	L
Holder unit set screw	Right-hand	Left-hand
Ball shank	Right-hand	

Precautions on Use

Link Ball

[Service Temperature]

The service temperature of the Link Ball series is basically between -20°C and 80°C . If the service temperature exceeds this range, contact THK. (See examples of testing the product at temperature other than the above service temperature range on [B22-8](#) to [B22-9](#).)

[Handling]

- (1) Do not disassemble the parts. This will result in loss of functionality.
- (2) Take care not to drop or strike the Link Ball. Doing so may cause injury or damage. Giving an impact to it could also cause damage to its function even if the product looks intact.
- (3) When handling the product, wear protective gloves, safety shoes, etc., as necessary to ensure safety.

[Precautions on Use]

- (1) Do not use the product in the manner that the permissible tilting angle is exceeded since doing so may damage the product.
- (2) Prevent foreign material, such as cutting chips or coolant, from entering the product. Failure to do so may cause damage.
- (3) Model BL is designed for use under loading in radial direction, while model RBI is designed for use under loading in axial direction.
- (4) Insufficient rigidity or accuracy of mounting members causes the bearing load to concentrate on one point and the bearing performance will drop significantly. Accordingly, give sufficient consideration to the rigidity/accuracy of the housing and base and strength of the fixing bolts.

[Lubrication]

- (1) Lithium soap group grease No. 2 is contained in all boots and can be used without further greasing.
- (2) Do not mix different lubricants. Mixing greases using the same type of thickening agent may still cause adverse interaction between the two greases if they use different additives, etc.
- (3) When using the product in locations exposed to constant vibrations or in special environments such as clean rooms, vacuum and low/high temperature, use the grease appropriate for the specification/environment.

[Storage]

When storing the Link Ball, enclose it in a package designated by THK and store it in a room while avoiding high temperature, low temperature and high humidity.

[Disposal]

Dispose of the product properly as industrial waste.